

# Leica MS50/TS50/TM50 User Manual



Version 1.1.1  
English

- when it has to be **right**

**Leica**  
Geosystems

# Introduction

## Purchase

Congratulations on the purchase of a MS50/TS50/TM50 series instrument.



This manual contains important safety directions as well as instructions for setting up the product and operating it. Refer to "1 Safety Directions" for further information. Read carefully through the User Manual before you switch on the product.

## Product identification

The type and serial number of your product are indicated on the type plate. Enter the type and serial number in your manual and always refer to this information when you need to contact your agency or Leica Geosystems authorised service workshop.

Type: \_\_\_\_\_

Serial No.: \_\_\_\_\_

## Trademarks



- Windows is a registered trademark of Microsoft Corporation in the United States and other countries
- Bluetooth® is a registered trademark of Bluetooth SIG, Inc.
- SD Logo is a trademark of SD-3C, LLC.



All other trademarks are the property of their respective owners.

## Validity of this manual

This manual applies to all MS50/TS50/TM50 instruments. Where there are differences between the various models they are clearly described.

## Available documentation

Name	Description/Format		
MS50/TS50/TM50 Quick Guide	Provides an overview of the product together with technical data and safety directions. Intended as a quick reference guide.	✓	✓
MS50/TS50/TM50 User Manual	All instructions required in order to operate the product to a basic level are contained in this User Manual. Provides an overview of the system together with technical data and safety directions.	-	✓

Name	Description/Format		
Nova TPS Getting Started Guide	Describes the general working of the product in standard use. Intended as a quick reference field guide.	-	✓
Viva GNSS Getting Started Guide	Describes the general working of the product in standard use. Intended as a quick reference field guide.	-	✓
Nova Series Technical Reference Manual	Overall comprehensive guide to the product and application functions. Included are detailed descriptions of special software/hardware settings and software/hardware functions intended for technical specialists.	-	✓

**Refer to the following resources for all MS50/TS50/TM50 documentation/software:**

- the Leica USB documentation card
- <https://myworld.leica-geosystems.com>

myWorld@Leica Geosystems (<https://myworld.leica-geosystems.com>) offers a wide range of services, information and training material.

With direct access to myWorld, you are able to access all relevant services whenever it is convenient for you, 24 hours a day, 7 days per week. This increases your efficiency and keeps you and your equipment instantly updated with the latest information from Leica Geosystems.

Service	Description
myProducts	Simply add all Leica Geosystems products that you and your company own. View detailed information on your products, buy additional options or Customer Care Packages (CCPs), update your products with the latest software and keep up-to-date with the latest documentation.
myService	View the service history of your products in Leica Geosystems Service Centers and detailed information on the services performed on your products. For your products that are currently in Leica Geosystems Service Centers view the current service status and the expected end date of service.
mySupport	Create new support requests for your products that will be answered by your local Leica Geosystems Support Team. View the complete history of your Support and view detailed information on each request in case you want to refer to previous support requests.
myTraining	Enhance your product knowledge with the Leica Geosystems Campus - Information, Knowledge, Training. Study the latest online training material or download training material on your products. Keep up-to-date with the latest News on your products and register for Seminars or Courses in your country.

# Table of Contents

In this manual	Chapter	Page
<b>1</b>	<b>Safety Directions</b>	<b>6</b>
1.1	General Introduction	6
1.2	Definition of Use	7
1.3	Limits of Use	7
1.4	Responsibilities	7
1.5	Hazards of Use	8
1.6	Laser Classification	10
1.6.1	General	10
1.6.2	Distancer, Measurements with Reflectors	10
1.6.3	Distancer, Measurements without Reflectors	11
1.6.4	Autofocus Capability of Telescope Camera	12
1.6.5	Automatic Target Aiming ATR	13
1.6.6	PowerSearch PS	14
1.6.7	Electronic Guide Light EGL	15
1.6.8	Laser Plummet	15
1.7	Electromagnetic Compatibility EMC	17
1.8	FCC Statement, Applicable in U.S.	18
<b>2</b>	<b>Description of the System</b>	<b>20</b>
2.1	System Components	20
2.2	System Concept	22
2.2.1	Software Concept	22
2.2.2	Power Concept	23
2.2.3	Data Storage Concept	24
2.3	Instrument Components	24
<b>3</b>	<b>User Interface</b>	<b>27</b>
3.1	Keyboard	27
3.2	Operating Principles	28
3.3	Autofocus Capability of Telescope Camera	28
<b>4</b>	<b>Operation</b>	<b>29</b>
4.1	Fixing the Display Foil to the TS	29
4.2	Connecting to a Personal Computer	30
4.3	Power Functions	32
4.4	Batteries	33
4.4.1	Operating Principles	33
4.4.2	Battery for the TS Instrument	33
4.4.3	Battery for SmartAntenna	34
4.5	Working with the Memory Device	35
4.6	LED Indicators	37
4.7	Guidelines for Correct Results	40
<b>5</b>	<b>Check &amp; Adjust</b>	<b>42</b>
5.1	Overview	42
5.2	Preparation	43
5.3	Combined Adjustment (l, t, i, c, ATR and tele camera)	44
5.4	Tilting Axis Adjustment (a)	45
5.5	Adjusting the Circular Level of the Instrument and Tribach	47
5.6	Adjusting the Circular Level of the Prism Pole	47

5.7	Inspecting the Laser Plummet of the Instrument	47
5.8	Servicing the Tripod	48
<b>6</b>	<b>Care and Transport</b>	<b>49</b>
6.1	Transport	49
6.2	Storage	49
6.3	Cleaning and Drying	49
6.4	Maintenance	50
<b>7</b>	<b>Technical Data</b>	<b>51</b>
7.1	Angle Measurement	51
7.2	Distance Measurement with Reflectors	51
7.3	Distance Measurement without Reflectors	53
7.4	Distance Measurement - Long Range (LO mode)	54
7.5	Automatic Target Aiming ATR	54
7.6	Scanning	56
7.7	PowerSearch PS	57
7.8	Overview Camera	57
7.9	Telescope Camera	57
7.10	SmartStation	58
	7.10.1 SmartStation Accuracy	58
	7.10.2 SmartStation Dimensions	58
	7.10.3 SmartAntenna Technical Data	59
7.11	Conformity to National Regulations	61
	7.11.1 MS50/TS50/TM50	61
	7.11.2 RadioHandle	62
	7.11.3 GS08plus	62
	7.11.4 GS12	63
	7.11.5 GS14	64
	7.11.6 GS15	65
	7.11.7 SLR1, SLR2, SATEL SATELLINE-3AS	66
	7.11.8 SLR5, SATEL SATELLINE M3-TR1	67
	7.11.9 SLR3-1, SLR3-2, Pacific Crest ADL	68
	7.11.10 SLG1, Telit UC864-G	69
	7.11.11 SLG2, CINTERION MC75i	70
	7.11.12 SLC1 (US), SLC2 (US) CDMA Telit CC864-DUAL	71
7.12	General Technical Data of the Instrument	72
7.13	Scale Correction	74
7.14	Reduction Formulas	77
<b>8</b>	<b>Software Licence Agreement</b>	<b>79</b>
	<b>Index</b>	<b>80</b>

# 1 Safety Directions

## 1.1 General Introduction

### Description

The following directions enable the person responsible for the product, and the person who actually uses the equipment, to anticipate and avoid operational hazards.

The person responsible for the product must ensure that all users understand these directions and adhere to them.

### About Warning Messages





Warning messages are an essential part of the safety concept of the instrument. They appear wherever hazards or hazardous situations can occur.

#### Warning messages...

- make the user alert about direct and indirect hazards concerning the use of the product.
- contain general rules of behaviour.

For the users' safety, all safety instructions and safety messages shall be strictly observed and followed! Therefore, the manual must always be available to all persons performing any tasks described herein.

**DANGER, WARNING, CAUTION** and **NOTICE** are standardized signal words for identifying levels of hazards and risks related to personal injury and property damage. For your safety it is important to read and fully understand the table below with the different signal words and their definitions! Supplementary safety information symbols may be placed within a warning message as well as supplementary text.

Type	Description
 <b>DANGER</b>	Indicates an imminently hazardous situation which, if not avoided, will result in death or serious injury.
 <b>WARNING</b>	Indicates a potentially hazardous situation or an unintended use which, if not avoided, could result in death or serious injury.
 <b>CAUTION</b>	Indicates a potentially hazardous situation or an unintended use which, if not avoided, may result in minor or moderate injury.
<b>NOTICE</b>	Indicates a potentially hazardous situation or an unintended use which, if not avoided, may result in appreciable material, financial and environmental damage.
	Important paragraphs which must be adhered to in practice as they enable the product to be used in a technically correct and efficient manner.

## 1.2 Definition of Use

---

### Intended use

- Measuring horizontal and vertical angles.
  - Measuring distances.
  - Recording measurements.
  - Capturing and recording images.
  - Automatic target search, recognition and -tracking.
  - Visualising the aiming direction and vertical axis.
  - Remote control of product.
  - Data communication with external appliances.
  - Measuring raw data and computing coordinates using carrier phase and code signal from GNSS satellites.
  - Carrying out measurement tasks using various GNSS measuring techniques.
  - Recording GNSS and point related data.
  - Computing with software.
- 

### Adverse use

- Use of the product without instruction.
  - Use outside of the intended use and limits.
  - Disabling safety systems.
  - Removal of hazard notices.
  - Opening the product using tools, for example screwdriver, unless this is permitted for certain functions.
  - Modification or conversion of the product.
  - Use after misappropriation.
  - Use of products with recognisable damages or defects.
  - Use with accessories from other manufacturers without the prior explicit approval of Leica Geosystems.
  - Inadequate safeguards at the working site.
  - Aiming directly into the sun.
- 

## 1.3 Limits of Use

---

### Environment

Suitable for use in an atmosphere appropriate for permanent human habitation: not suitable for use in aggressive or explosive environments.

---



**DANGER**

Local safety authorities and safety experts must be contacted before working in hazardous areas, or close to electrical installations or similar situations by the person in charge of the product.

---

## 1.4 Responsibilities

---

### Manufacturer of the product

Leica Geosystems AG, CH-9435 Heerbrugg, hereinafter referred to as Leica Geosystems, is responsible for supplying the product, including the user manual and original accessories, in a safe condition.

---

### Person responsible for the product

- The person responsible for the product has the following duties:
- To understand the safety instructions on the product and the instructions in the user manual.
  - To ensure that it is used in accordance with the instructions.
  - To be familiar with local regulations relating to safety and accident prevention.
  - To inform Leica Geosystems immediately if the product and the application becomes unsafe.
  - To ensure that the national laws, regulations and conditions for the operation of e.g. radio transmitters, lasers are respected.
-

**CAUTION**

Watch out for erroneous measurement results if the product has been dropped or has been misused, modified, stored for long periods or transported.

**Precautions:**

Periodically carry out test measurements and perform the field adjustments indicated in the user manual, particularly after the product has been subjected to abnormal use and before and after important measurements.

**DANGER**

Because of the risk of electrocution, it is dangerous to use poles and extensions in the vicinity of electrical installations such as power cables or electrical railways.

**Precautions:**

Keep at a safe distance from electrical installations. If it is essential to work in this environment, first contact the safety authorities responsible for the electrical installations and follow their instructions.

**NOTICE**

With the remote control of products, it is possible that extraneous targets will be picked out and measured.

**Precautions:**

When measuring in remote control mode, always check your results for plausibility.

**CAUTION**

Be careful when pointing the product towards the sun, because the telescope functions as a magnifying glass and can injure your eyes and/or cause damage inside the product.

**Precautions:**

Do not point the product directly at the sun.

**WARNING**

During dynamic applications, for example stakeout procedures there is a danger of accidents occurring if the user does not pay attention to the environmental conditions around, for example obstacles, excavations or traffic.

**Precautions:**

The person responsible for the product must make all users fully aware of the existing dangers.

**WARNING**

Inadequate securing of the working site can lead to dangerous situations, for example in traffic, on building sites, and at industrial installations.

**Precautions:**

Always ensure that the working site is adequately secured. Adhere to the regulations governing safety and accident prevention and road traffic.

**CAUTION**

If the accessories used with the product are not properly secured and the product is subjected to mechanical shock, for example blows or falling, the product may be damaged or people can sustain injury.

**Precautions:**

When setting-up the product, make sure that the accessories are correctly adapted, fitted, secured, and locked in position.

Avoid subjecting the product to mechanical stress.

**WARNING**

If the product is used with accessories, for example masts, staffs, poles, you may increase the risk of being struck by lightning.

**Precautions:**

Do not use the product in a thunderstorm.



**CAUTION**

During the transport, shipping or disposal of batteries it is possible for inappropriate mechanical influences to constitute a fire hazard.

**Precautions:**

Before shipping the product or disposing of it, discharge the batteries by running the product until they are flat.

When transporting or shipping batteries, the person in charge of the product must ensure that the applicable national and international rules and regulations are observed. Before transportation or shipping contact your local passenger or freight transport company.

---

**WARNING**

High mechanical stress, high ambient temperatures or immersion into fluids can cause leakage, fire or explosions of the batteries.

**Precautions:**

Protect the batteries from mechanical influences and high ambient temperatures. Do not drop or immerse batteries into fluids.

---

**WARNING**

If battery terminals are short circuited e.g. by coming in contact with jewellery, keys, metalized paper or other metals, the battery can overheat and cause injury or fire, for example by storing or transporting in pockets.

**Precautions:**

Make sure that the battery terminals do not come into contact with metallic objects.

---

**WARNING**

If the product is improperly disposed of, the following can happen:

- If polymer parts are burnt, poisonous gases are produced which may impair health.
- If batteries are damaged or are heated strongly, they can explode and cause poisoning, burning, corrosion or environmental contamination.
- By disposing of the product irresponsibly you may enable unauthorised persons to use it in contravention of the regulations, exposing themselves and third parties to the risk of severe injury and rendering the environment liable to contamination.

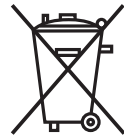
**Precautions:**

The product must not be disposed with household waste.

Dispose of the product appropriately in accordance with the national regulations in force in your country.

Always prevent access to the product by unauthorised personnel.

Product-specific treatment and waste management information can be downloaded from the Leica Geosystems home page at <http://www.leica-geosystems.com/treatment> or received from your Leica Geosystems dealer.

---

**WARNING**

Only Leica Geosystems authorised service workshops are entitled to repair these products.

---

## 1.6

## Laser Classification

### 1.6.1

### General

#### General

The following chapters provide instructions and training information about laser safety according to international standard IEC 60825-1 (2007-03) and technical report IEC TR 60825-14 (2004-02). The information enables the person responsible for the product and the person who actually uses the equipment, to anticipate and avoid operational hazards.

- ☞ According to IEC TR 60825-14 (2004-02), products classified as laser class 1, class 2 and class 3R do not require:
- laser safety officer involvement,
  - protective clothes and eyewear,
  - special warning signs in the laser working area
- if used and operated as defined in this User Manual due to the low eye hazard level.
- ☞ National laws and local regulations could impose more stringent instructions for the safe use of lasers than IEC 60825-1 (2007-03) and IEC TR 60825-14 (2004-02).

### 1.6.2

### Distancer, Measurements with Reflectors

#### General

The EDM module built into the product produces a visible laser beam which emerges from the telescope objective.

The laser product described in this section is classified as laser class 1 in accordance with:

- IEC 60825-1 (2007-03): "Safety of laser products"
- EN 60825-1 (2007-10): "Safety of laser products"

These products are safe under reasonably foreseeable conditions of operation and are not harmful to the eyes provided that the products are used and maintained in accordance with this User Manual.

Description	Value	
	TS50/TM50	MS50
Wavelength	650 nm - 690 nm	
Maximum average radiant power	0.33 mW	
Pulse duration	800 ps	700 ps
Pulse repetition frequency (PRF)	100 MHz	1.1 MHz
Beam divergence	1.5 mrad x 3 mrad	

#### Labelling

Class 1 Laser Product  
according to IEC 60825-1  
(2007 - 03)

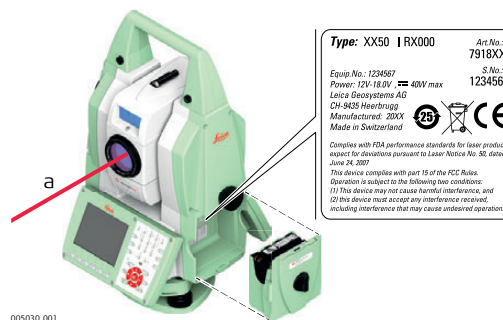

a) Laser beam

**General**

The EDM module built into the product produces a visible laser beam which emerges from the telescope objective.

The laser product described in this section is classified as laser class 3R in accordance with:

- IEC 60825-1 (2007-03): "Safety of laser products"
- EN 60825-1 (2007-10): "Safety of laser products"

Direct intrabeam viewing may be hazardous (low eye hazard level), in particular for deliberate ocular exposure. The beam may cause dazzle, flash-blindness and after-images, particularly under low ambient light conditions. The risk of injury for laser class 3R products is limited because of:

- a) unintentional exposure would rarely reflect worst case conditions of (e.g.) beam alignment with the pupil, worst case accommodation,
- b) inherent safety margin in the maximum permissible exposure to laser radiation (MPE)
- c) natural aversion behaviour for exposure to bright light for the case of visible radiation.

Description	Value	
	TS50/TM50	MS50
Wavelength	650 nm - 690 nm	
Maximum average radiant power	4.75 mW ± 5%	1.7 mW ± 5%
Pulse duration	800 ps	1.5 ns
Pulse repetition frequency (PRF)	100 MHz	RL-Tracking, RL-Scan: 2 MHz RL-Pointer: 4 MHz
Beam divergence	0.2 mrad x 0.3 mrad	
NOHD (Nominal Ocular Hazard Distance) @ 0.25s	82 m / 269 ft	46 m / 150.9 ft



**CAUTION**

From a safety perspective, class 3R laser products should be treated as potentially hazardous.

**Precautions:**

- 1) Prevent direct eye exposure to the beam.
- 2) Do not direct the beam at other people.



**CAUTION**

Potential hazards are not only related to direct beams but also to reflected beams aimed at reflecting surfaces such as prisms, windows, mirrors, metallic surfaces, etc.

**Precautions:**

- 1) Do not aim at areas that are essentially reflective, such as a mirror, or which could emit unwanted reflections.
- 2) Do not look through or beside the optical sight at prisms or reflecting objects when the laser is switched on, in laser pointer or distance measurement mode. Aiming at prisms is only permitted when looking through the telescope.

**Labelling**

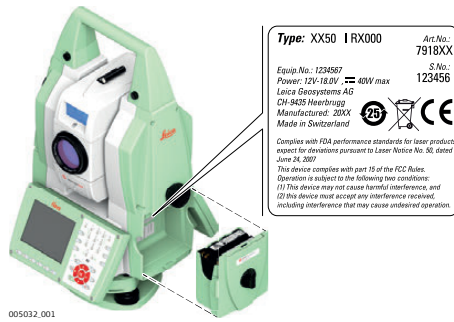
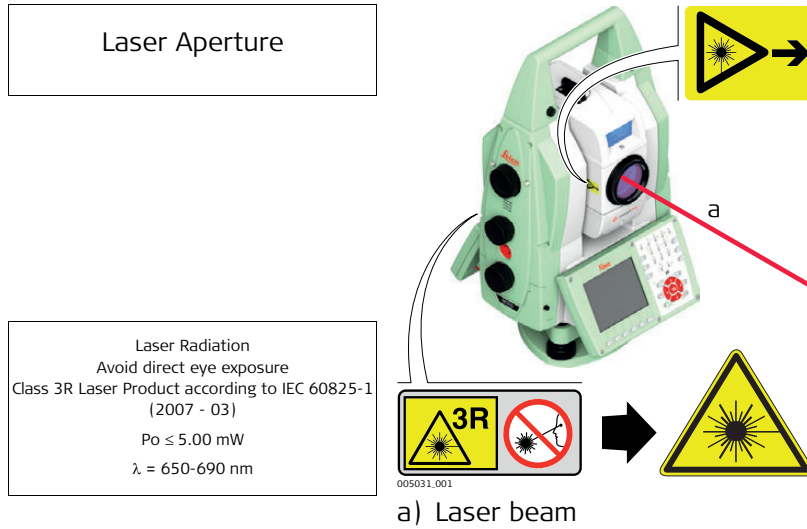

**1.6.4 Autofocus Capability of Telescope Camera**

**General**

The models TS50, TM50 I and MS50 of Leica Nova series contain a coaxial telescope camera with autofocus capability. When using the auto focus functions a visible laser beam may emerge from the telescope (depending on the focussing mode).

The laser product described in this section is classified as laser class 1 in accordance with:

- IEC 60825-1 (2007-03): "Safety of laser products"
- EN 60825-1 (2007-10): "Safety of laser products"

These products are safe under reasonably foreseeable conditions of operation and are not harmful to the eyes provided that the products are used and maintained in accordance with this User Manual.

Description	Value	
	TS50/TM50	MS50
Wavelength	650 nm - 690 nm	
Maximum average radiant power	0.37 mW	0.1 mW
Pulse duration	800 ps	1.5 ns
Pulse repetition frequency (PRF)	100 MHz	Irregular packages max. 670 kHz
Beam divergence	0.2 mrad x 0.3 mrad	
Wavelength	650 nm - 690 nm	

## Labelling

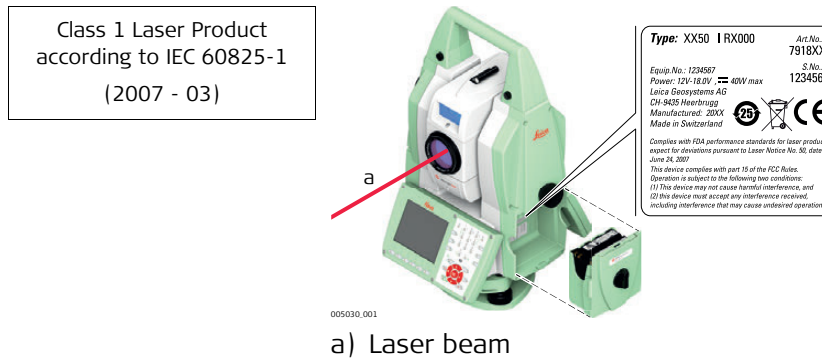

## 1.6.5

### Automatic Target Aiming ATR

#### General

The Automatic Target Aiming built into the product produces an invisible laser beam which emerges from the telescope objective.

The laser product described in this section is classified as laser class 1 in accordance with:

- IEC 60825-1 (2007-03): "Safety of laser products"
- EN 60825-1 (2007-10): "Safety of laser products"

These products are safe under reasonably foreseeable conditions of operation and are not harmful to the eyes provided that the products are used and maintained in accordance with this User Manual.

Description	Value		
	TM50	TS50	MS50
Wavelength	785 nm		
Maximum average radiant power	3 mW	6.2 mW	
Pulse duration	≤17 ms		
Pulse repetition frequency (PRF)	≤29 Hz	≤194 Hz	≤180 Hz
Beam divergence	11 mrad	25 mrad	

## Labelling

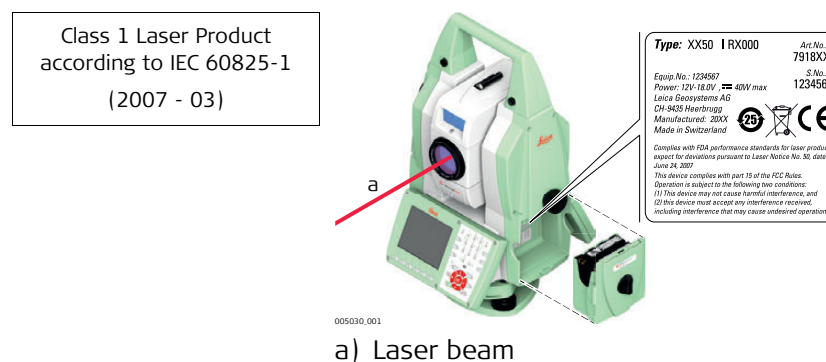



This is only applicable for MS50 and TS50 I.

**General**

The PowerSearch built into the product produces an invisible laser beam which emerges from the front side of the telescope.

The laser product described in this section is classified as laser class 1 in accordance with:

- IEC 60825-1 (2007-03): "Safety of laser products"
- EN 60825-1 (2007-10): "Safety of laser products"

These products are safe under reasonably foreseeable conditions of operation and are not harmful to the eyes provided that the products are used and maintained in accordance with this User Manual.

Description	Value
Wavelength	850 nm
Maximum average radiant power	11 mW
Pulse duration	20 ns, 40 ns
Pulse repetition frequency (PRF)	24.4 kHz
Beam divergence	0.4 mrad x 700 mrad

**Labelling**

Class 1 Laser Product  
according to IEC 60825-1  
(2007 - 03)

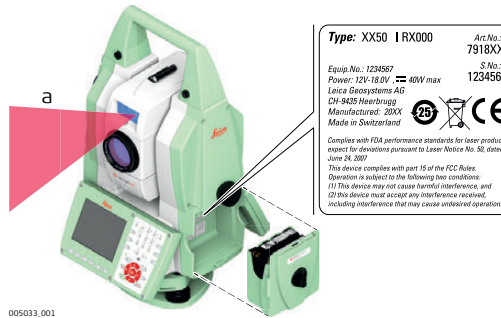

005033\_001  
a) Laser beam

## 1.6.7

## Electronic Guide Light EGL



This is only applicable for MS50 and TS50 I.

### General

The Electronic Guide Light built into the product produces a visible LED beam which emerges from the front side of the telescope.



The product described in this section, is excluded from the scope of IEC 60825-1 (2007-03): "Safety of laser products".

The product described in this section, is classified as exempt group in accordance with IEC 62471 (2006-07) and does not pose any hazard provided that the product is used and maintained in accordance with this user manual.

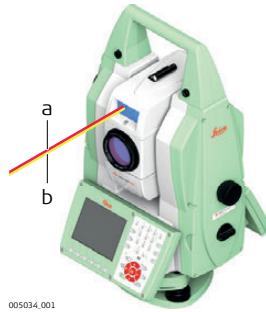

- a) LED beam red
- b) LED beam yellow

## 1.6.8

## Laser Plummet

### General

The laser plummet built into the product produces a visible red laser beam which emerges from the bottom of the product.

The laser product described in this section is classified as laser class 2 in accordance with:

- IEC 60825-1 (2007-03): "Safety of laser products"
- EN 60825-1 (2007-10): "Safety of laser products"

These products are safe for momentary exposures but can be hazardous for deliberate staring into the beam. The beam may cause dazzle, flash-blindness and after-images, particularly under low ambient light conditions.

Description	Value
Wavelength	650 nm - 690 nm
Maximum average radiant power	0.95 mW
Pulse duration	c.w.
Pulse repetition frequency (PRF)	c.w.
Beam divergence	< 1.5 mrad



### CAUTION

From a safety perspective, class 2 laser products are not inherently safe for the eyes.

#### Precautions:

- 1) Avoid staring into the beam.
- 2) Avoid pointing the beam at other people.

# Labelling

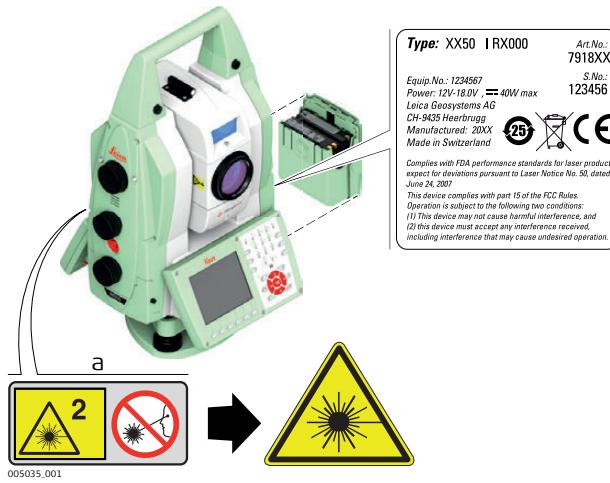

Laser Radiation  
 Do not stare into the beam  
 Class 2 Laser Product  
 according to IEC 60825-1  
 (2007 - 03)  
 $P_o \leq 1.00$  mW  
 $\lambda = 620 - 690$  nm

a) Will be replaced by a class 3R warning label if applicable

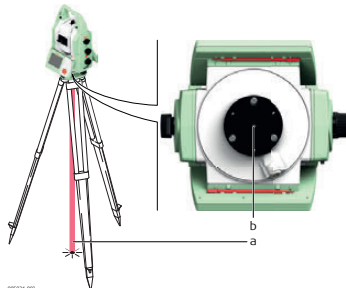

- a) Laser beam
- b) Exit for laser beam



**Description**

The term Electromagnetic Compatibility is taken to mean the capability of the product to function smoothly in an environment where electromagnetic radiation and electrostatic discharges are present, and without causing electromagnetic disturbances to other equipment.

**WARNING**

Electromagnetic radiation can cause disturbances in other equipment.

Although the product meets the strict regulations and standards which are in force in this respect, Leica Geosystems cannot completely exclude the possibility that other equipment may be disturbed.

**CAUTION**

There is a risk that disturbances may be caused in other equipment if the product is used with accessories from other manufacturers, for example field computers, personal computers or other electronic equipment, non-standard cables or external batteries.

**Precautions:**

Use only the equipment and accessories recommended by Leica Geosystems. When combined with the product, they meet the strict requirements stipulated by the guidelines and standards. When using computers or other electronic equipment, pay attention to the information about electromagnetic compatibility provided by the manufacturer.

**CAUTION**

Disturbances caused by electromagnetic radiation can result in erroneous measurements.

Although the product meets the strict regulations and standards which are in force in this respect, Leica Geosystems cannot completely exclude the possibility that the product may be disturbed by intense electromagnetic radiation, for example, near radio transmitters, two-way radios or diesel generators.

**Precautions:**

Check the plausibility of results obtained under these conditions.

**CAUTION**

If the product is operated with connecting cables attached at only one of their two ends, for example external supply cables, interface cables, the permitted level of electromagnetic radiation may be exceeded and the correct functioning of other products may be impaired.

**Precautions:**

While the product is in use, connecting cables, for example product to external battery, product to computer, must be connected at both ends.

**Radios or digital cellular phones****WARNING**

Use of product with radio or digital cellular phone devices:

Electromagnetic fields can cause disturbances in other equipment, in installations, in medical devices, for example pacemakers or hearing aids and in aircraft. It can also affect humans and animals.

**Precautions:**

Although the product meets the strict regulations and standards which are in force in this respect, Leica Geosystems cannot completely exclude the possibility that other equipment can be disturbed or that humans or animals can be affected.

- Do not operate the product with radio or digital cellular phone devices in the vicinity of filling stations or chemical installations, or in other areas where an explosion hazard exists.
- Do not operate the product with radio or digital cellular phone devices near to medical equipment.
- Do not operate the product with radio or digital cellular phone devices in aircraft.



The greyed paragraph below is only applicable for products without radio.



**WARNING**

This equipment has been tested and found to comply with the limits for a Class B digital device, pursuant to part 15 of the FCC rules. These limits are designed to provide reasonable protection against harmful interference in a residential installation. This equipment generates, uses and can radiate radio frequency energy and, if not installed and used in accordance with the instructions, may cause harmful interference to radio communications. However, there is no guarantee that interference will not occur in a particular installation. If this equipment does cause harmful interference to radio or television reception, which can be determined by turning the equipment off and on, the user is encouraged to try to correct the interference by one or more of the following measures:

- Reorient or relocate the receiving antenna.
- Increase the separation between the equipment and the receiver.
- Connect the equipment into an outlet on a circuit different from that to which the receiver is connected.
- Consult the dealer or an experienced radio/TV technician for help.



**WARNING**

Changes or modifications not expressly approved by Leica Geosystems for compliance could void the user's authority to operate the equipment.

**Labelling  
MS50/TS50/TM50**

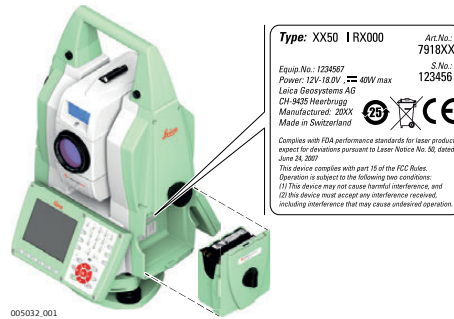

**Labelling GS08plus,  
GS12**

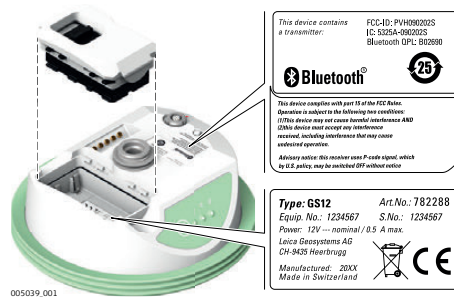

**Labelling GS14**

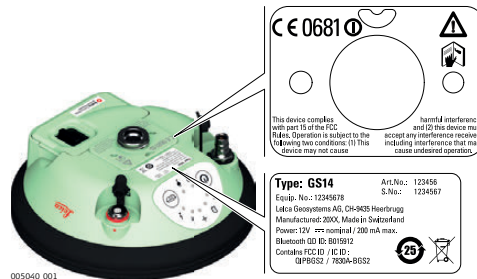

## Labelling GS15

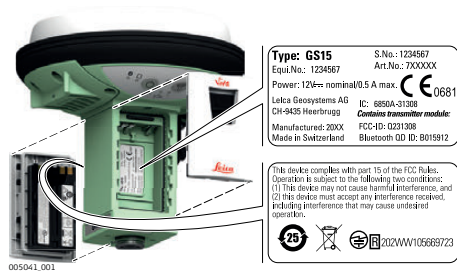

## FCC Labelling GEB242

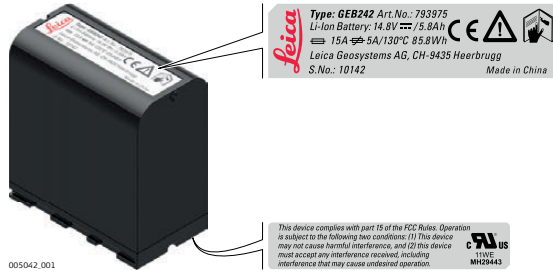

## Labelling internal battery GEB211, GEB212, GEB221, GEB222

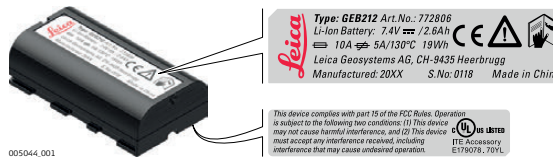

## Labelling Radio-Handle

### RH15

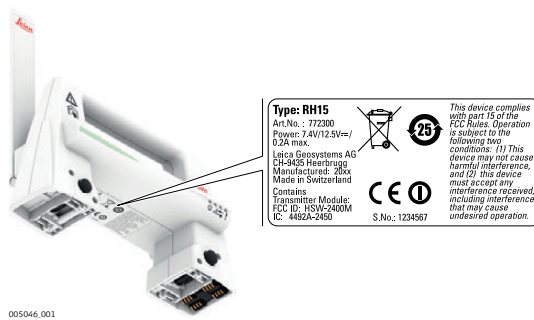

### RH16

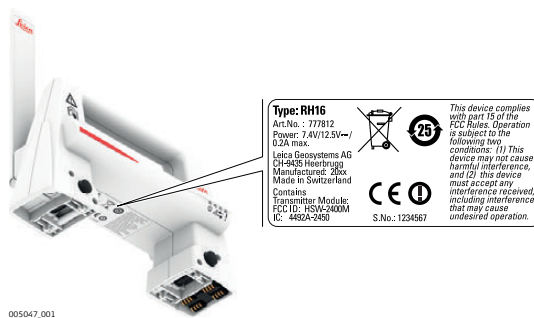

## 2 Description of the System

### 2.1 System Components

**General description** MS50/TS50/TM50 is a collective term describing high-end total stations of the Leica Nova Series.

#### Main components



Component	Description
MS50/TS50/TM50	<ul style="list-style-type: none"> <li>• an instrument for measuring, calculating and capturing data.</li> <li>• comprised of various models with a range of accuracy classes.</li> <li>• integrated with an add-on GNSS system to form Smart-Station.</li> <li>• combined with a CS field controller to conduct remote control surveys.</li> <li>• connected with LEICA Infinity to view, exchange and manage data.</li> </ul>
CS field controller	A multi-purpose field controller enabling the remote control of MS50/TS50/TM50.
LEICA Infinity	An office software consisting of a suite of standard and extended programs for the viewing, exchange and management of data.

#### Terms and abbreviations

The following terms and abbreviations can be found in this manual:

Term	Description
RCS	<b>Remote Control Surveying</b>
EDM	<p><b>Electronic Distance Measurement</b></p> <p>EDM refers to the laser distancer incorporated into the instrument which enables distance measurement.</p> <p>Two measuring modes are available:</p> <ul style="list-style-type: none"> <li>• <b>Prism</b> mode. This mode refers to the ability to measure distances to prisms. On the TS50/TM50, it incorporates the <b>LO</b> mode to measure extended distances to prisms. On the MS50, the <b>STD</b> mode is used for the whole distance range including extended distance prisms.</li> <li>• <b>Any surface</b> mode. This mode refers to the ability to measure distances without prisms.</li> </ul>
PinPoint	PinPoint refers to the Reflectorless EDM technology which enables an increased measuring range with a smaller laser spot size. Two options are available: R1000 and R2000.

Term	Description
EGL	<b>Electronic Guide Light</b> An EGL fitted to an instrument assists with prism targeting. It consists of two differently coloured flashing lights located in the instrument telescope housing. The person holding the prism can align themselves into the line-of-sight of the instrument.
ATR	<b>Automated Target Aiming.</b> ATR refers to the instrument sensor which enables the automatic target aiming to a prism.
Autofocus	Instruments equipped with autofocus offer an automatic focussing of the telescope optics.
Automated	Instruments fitted with Target aiming are referred to as <b>Automated</b> .  Target aiming refers to the instrument sensor which enables the automatic target aiming to a prism.  Three automation modes are available with Target aiming: <ul style="list-style-type: none"> <li>• Manual: no Target aiming - no automation and no lock.</li> <li>• Automatic: automatic target aiming to a prism.</li> <li>• LOCK: automatic tracking of an already targeted prism.</li> </ul>
Telescope camera	The camera is coaxially located in the instruments telescope using the 30x magnification of the telescope optics.
Overview camera	The overview camera is located in the upper part of the telescope housing and has a fixed focus without optical magnification.
PowerSearch	<b>PowerSearch</b> refers to the instrument sensor which enables the automatic rapid finding of a prism.
SmartStation	A Leica Nova TPS instrument integrated with an add-on GNSS system, comprising hardware and software components, forms a SmartStation.  Components of a SmartStation include a SmartAntenna and a SmartAntenna Adapter.  A SmartStation provides an additional instrument setup method for determining instrument station coordinates.  The GNSS principles and functionality of a SmartStation derive from the principles and functionality of Leica Viva GNSS instruments.
SmartAntenna	SmartAntenna with integrated Bluetooth is a component of a SmartStation. It can also be used independently on a pole with a CS10/CS15 field controller. Models compatible with a MS50/TS50/TM50 instrument are GS08plus/GS12/GS14/GS15. Where there are differences between the various models they are clearly described.
RadioHandle	A component of RCS is the RH15/RH16 RadioHandle. It is an instrument carry handle with an integrated radio modem with attached antenna.
Communication side cover	Communication side cover with integrated Bluetooth, SD card slot, USB port, WLAN and integrated RadioHandle is standard for a MS50/TS50/TM50 instrument and a component of a SmartStation. In combination with the RH15/RH16 RadioHandle, it is also a component of RCS.

## Instrument models

Model	TM50 R1000	TM50 I R1000	TS50 I R1000	MS50 R2000
Angle measurement	✓	✓	✓	✓
Distance measurement to prism	✓	✓	✓	✓
Distance measurement to any surface (reflectorless)	✓	✓	✓	✓
Motorised	✓	✓	✓	✓
Automatic Target Aiming (long range)	✓	✓	-	-
Automatic Target Aiming	-	-	✓	✓
Lock	-	-	✓	✓
PowerSearch (PS)	-	-	✓	✓
Overview camera	-	✓	✓	✓
Telescope camera	-	✓	✓	✓
Scanning	-	-	-	✓
RS232 and USB interface	✓	✓	✓	✓
SD card and USB stick as storage device	✓	✓	✓	✓
Bluetooth	✓	✓	✓	✓
WLAN	✓	✓	✓	✓
Internal Flash Memory (1 GB)	✓	✓	✓	✓
Hotshoe interface for RadioHandle	✓	✓	✓	✓
Guide Light (EGL)	-	-	✓	✓
Autofocus	-	✓	✓	✓
Uninterruptible electronic power supply due to internal charging functionality	✓	✓	✓	✓

## 2.2

### System Concept

### 2.2.1

### Software Concept

#### Description

All instruments use the same software concept.

#### Software for TS models

Software type	Description
TS firmware (TS_xx.fw)	<p>This important software covers all functions of the instrument.</p> <p>The applications Survey and Setup are integrated into the firmware and cannot be deleted.</p> <p>The English language is integrated into the firmware and cannot be deleted.</p>
Language software (SYS_LANG.sxx)	<p>Numerous languages are available for the TS instruments. This software is also referred to as system language.</p> <p>The English language is the default language. One language is chosen as the active language.</p>
Applications (xx.axx)	<p>Many optional survey-specific applications are available for the TS instruments.</p> <p>Some of the applications are activated freely and require no licence key, and others require purchasing and are only activated with a licence key.</p>

Software type	Description
	Applications requiring an activation run for a 180 days trial period without prior activation.
Customised applications (xx.axx)	Customised software, specific to user requirements, can be developed using the GeoC++ development kit in addition to run Windows CE-based applications if GeoCOM robotics licence is available. Information on the GeoC++ development environment is available on request from a Leica Geosystems representative.

## Software upload

-  Uploading software can take some time. Ensure that the battery is at least 75% full before beginning the upload, and do not remove the battery during the upload process.

Software for	Description
All TS models	<p>The SmartWorx Viva is stored in the flash RAM of the TS instrument.</p> <p><b>Software update instructions</b></p> <ul style="list-style-type: none"> <li>• Download the most recent TS firmware file from <a href="https://myworld.leica-geosystems.com">https://myworld.leica-geosystems.com</a>. Refer to "Introduction".</li> <li>• Connect the TS instrument to your PC. Refer to "4.2 Connecting to a Personal Computer".</li> <li>• Copy the TS firmware file onto a folder system on the Leica SD card.</li> <li>• Start the TS instrument. In SmartWorx Viva select <b>User\Tools &amp; other utilities\Load firmware &amp; Apps</b>. Select <b>Object to transfer: Firmware</b>.</li> <li>• A message will appear when the upload is complete.</li> </ul>

## 2.2.2

### Power Concept

#### General

Use the Leica Geosystems batteries, chargers and accessories or accessories recommended by Leica Geosystems to ensure the correct functionality of the instrument.

#### Power options

Model	Power supply
MS50/TS50/TM50	<p>Internally by GEB242 battery, OR</p> <p>Externally by GEV219 cable and GEB171 battery.</p> <p>If an external power supply is connected and the internal battery is inserted, then the external power is used for the standard setting. It is possible to configure the main power source to either internal battery or external power supply. If both power sources are available the internal battery serves as an uninterruptible electronic power supply due to internal charging functionality of the internal battery.</p>
SmartAntenna	Internally via GEB211/GEB212 battery fitted into the antenna.

## 2.2.3

## Data Storage Concept

### Description

Data is stored on a memory device. The memory device can be an SD card or internal memory. For data transfer an USB stick can also be used.

### Memory device

SD card: All instruments have an SD card slot fitted as standard. An SD card can be inserted and removed. Available capacity: 1 GB and 8 GB.

USB stick: All instruments have a USB port fitted as standard.

Internal memory: All instruments have an internal memory fitted as standard. Available capacity: 1 GB.

☞ While other SD cards can be used, Leica Geosystems recommends to only use Leica SD cards and is not responsible for data loss or any other error that can occur while using a non-Leica card.



Unplugging connecting cables or removing the SD card or USB stick during the measurement can cause loss of data. Only remove the SD card or USB stick or unplug connecting cables when the TS instrument is switched off.

### Transfer data

Data can be transferred in various ways. Refer to "4.2 Connecting to a Personal Computer".



SD cards can directly be used in an OMNI drive as supplied by Leica Geosystems. Other PC card drives can require an adaptor.

## 2.3

## Instrument Components

### Instrument components part 1 of 2

A MS50/TS50 instrument is shown.

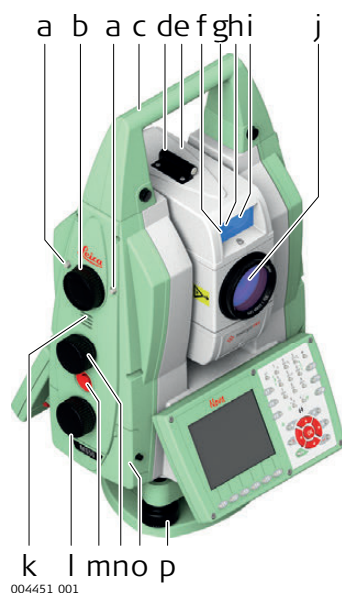

- a) Autofocus button
- b) Servofocus drive
- c) Carry handle
- d) Optical sight
- e) Telescope with EDM, ATR and, if available, camera sensors. For MS50/TS50 also EGL and PS.
- f) EGL, for MS50/TS50
- g) Overview camera, for MS50/TS50/TM50 I
- h) PowerSearch, transmitter, for MS50/TS50
- i) PowerSearch, receiver, for MS50/TS50
- j) Coaxial optics for angle and distance measurements, telescope camera and exit port for visible laser beam for distance measurement
- k) Loud speaker
- l) Horizontal drive
- m) User defined SmartKey
- n) Vertical drive
- o) SD card and USB stick compartment
- p) Tribrach footscrew



## Instrument components part 2 of 2



- q) Interchangeable eyepiece
- r) Circular level
- s) Stylus for touch screen
- t) Battery compartment
- u) Vertical drive
- v) Tribrach securing screw
- w) Screen
- x) Keyboard; for TM50 second keyboard optional

## Communication side cover

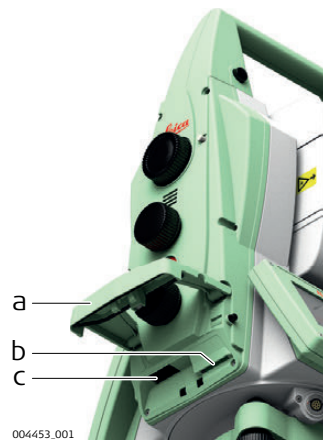

- a) Compartment lid
- b) SD card port
- c) USB host port for USB stick

## Instrument components for SmartStation

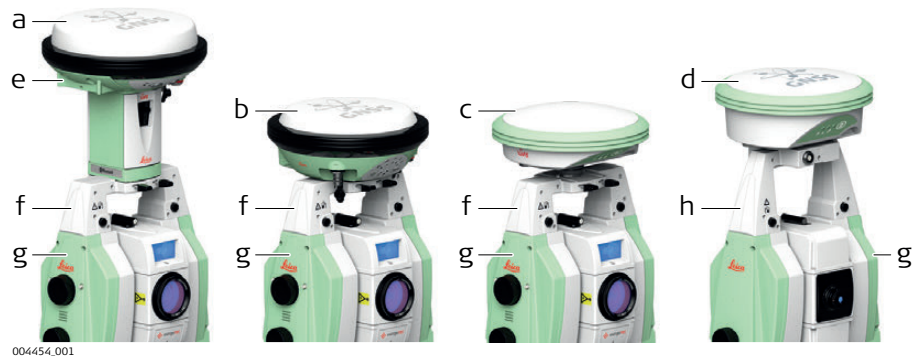

- a) GS15 SmartAntenna
- b) GS14 SmartAntenna
- c) GS08plus SmartAntenna
- d) GS12 SmartAntenna
- e) RTK slot-in device
- f) GAD110 SmartAntenna Adapter
- g) Communication side cover
- h) GAD104 SmartAntenna Adapter

## Instrument components for RCS

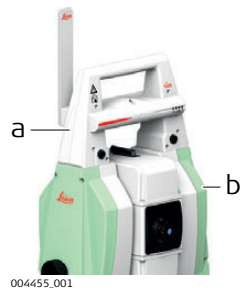

- a) RadioHandle
  - b) Communication side cover
-

# 3 User Interface

## 3.1 Keyboard

### Keyboard MS50/TS50/TM50

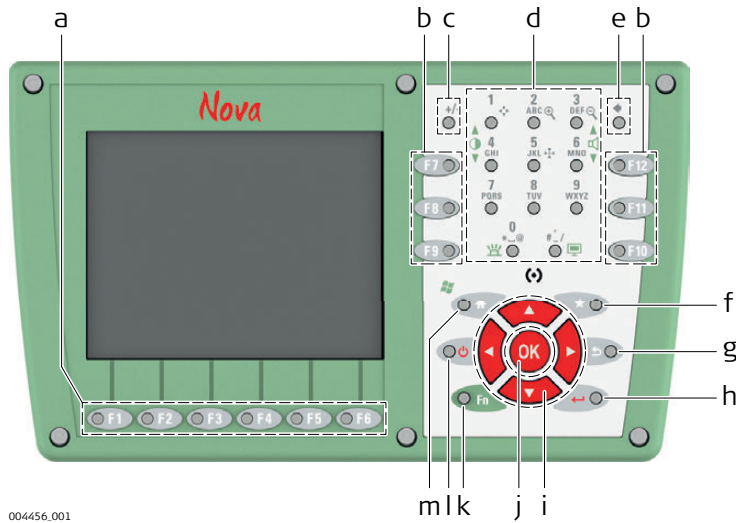



004456.001

- a) Function keys **F1 - F6**
- b) Function keys **F7 - F12**
- c)  $\pm$  key
- d) Alphanumeric keys
- e) Backspace
- f) Favourites
- g) ESC
- h) ENTER
- i) Arrow keys
- j) **OK**
- k) **Fn**
- l) ON/OFF
- m) Home

### Keys

Key	Function
Function keys <b>F1-F6</b>	Correspond to six softkeys that appear on the bottom of the screen when the screen is activated.
Function keys <b>F7-F12</b>	User definable keys to execute chosen commands or access chosen screens.
Alphanumeric keys	To type letters and numbers.
Esc	Leaves the current screen without storing any changes.
<b>Fn</b>	Switches between the first and second level of function keys.
Enter	Selects the highlighted line and leads to the next logical menu / dialog. Starts the edit mode for editable fields. Opens a selectable list.
ON/OFF	If the instrument is already off: Turns on the instrument when held for 2 s. If the instrument is already on: Turns to Power Options menu when held for 2 s.
Favourites	Goes to a favourites menu.
Home	Switches to the SmartWorx Viva Main Menu. Switches to the Windows CE Start Menu when pressing Fn at the same time.

Key		Function
Arrow keys		Move the focus on the screen.
OK		Selects the highlighted line and leads to the next logical menu / dialog. Starts the edit mode for editable fields. Opens a selectable list.

## 3.2 Operating Principles

### Keyboard and touch screen

The user interface is operated either by the keyboard or by the touch screen with supplied stylus. The workflow is the same for keyboard and touch screen entry, the only difference lies in the way information is selected and entered.

#### Operation by keyboard

Information is selected and entered using the keys. Refer to "3.1 Keyboard" for a detailed description of the keys on the keyboard and their function.

#### Operation by touch screen

Information is selected and entered on the screen using the supplied stylus.

Operation	Description
To select an item	Tap on the item.
To start the edit mode in editable fields	Tap on the editable field.
To highlight an item or parts of it for editing	Drag the supplied stylus from the left to the right.
To accept data entered into an editable field and exit the edit mode	Tap on the screen outside of the editable field.
To open a context-sensitive menu	Tap on the item and hold for 2 s.

## 3.3 Autofocus Capability of Telescope Camera

### Functionality

The autofocus button is located on the side cover.

Action	Function
Pressing 1x	A single autofocus is executed. The autofocus is related to the selected EDM mode (prism or non-prism measurements).
Pressing 2x	The refocus is executed. Based on the actual focus lens position, a refocus is performed. A refocus does a small movement of the focussing lens to find the best focus position.
Holding for 2 sec	The continuous autofocus is started. By pressing the button again or by turning the servofocus wheel, the continuous autofocus is stopped.

## 4

## Operation

### 4.1

### Fixing the Display Foil to the TS



We strongly recommend to use the display foil to protect the display against scratches and dirt and to guarantee a trouble-free function of the touchscreen in extreme and humid weather conditions.

All instruments are delivered ex factory with an already fixed display foil.

#### Preparation

- Ensure that the display is free of dust and grease.
- Use the provided microfibre cloth to clean the display.
- Look for a dust free and dry atmosphere surrounding while fixing the display foil. The recommended conditions are:

Temperature: approx. 21°C

Humidity: < 55%

#### Fixing the display foil step-by-step

The display foil lies between two thin carrier foils. The display foil has a silver-coloured sticker to peel away the carrier foil from the actual display foil.

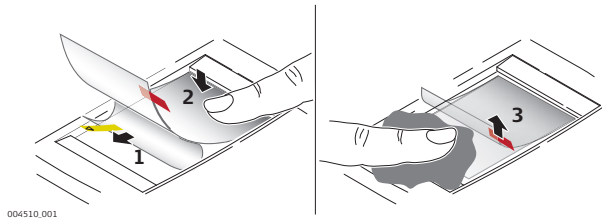

Step	Description
1.	Touch the yellow-coloured sticker with two fingers and pull it slowly upwards. The carrier foil is peeling away. Do not peel the carrier foil more than 2 cm - 3 cm away.
2.	Fix the adhesive underside of the display foil on the display edge. Peel away the carrier foil slowly and smooth it out gently onto the display.
3.	Remove the additional layer foil which has a red-coloured sticker.
4.	Potential air bubbles between display and display foil have to be smoothed out using the included microfibre cloth. Do not use sharp objects!
5.	In case of remaining dust or grease under the display foil or the need to replace the display foil, lift it again with some adhesive tape.



Microsoft ActiveSync (for PCs with Windows XP operating system) or Windows Mobile Device Center (for PCs with Windows Vista or Windows 7/Windows 8 operating system) is the synchronisation software for Windows mobile-based pocket PCs. Microsoft ActiveSync or Windows Mobile Device Center enables a PC and a Windows mobile-based pocket PC to communicate.

### Install Leica Viva USB drivers

Step	Description
1.	Start the PC.
2.	Insert the Leica Viva Series USB card.
3.	Run the <b>SetupViva&amp;GR_USB_XX.exe</b> to install the drivers necessary for Leica Viva devices. Depending on the version (32bit or 64bit) of the operating system on your PC, you have to select between the three setup files following: <ul style="list-style-type: none"> <li>• SetupViva&amp;GR_USB_32bit.exe</li> <li>• SetupViva&amp;GR_USB_64bit.exe</li> <li>• SetupViva&amp;GR_USB_64bit_itanium.exe</li> </ul> The setup has to be run only once for all Leica Viva devices.
4.	The <b>Welcome to InstallShield Wizard for Leica Viva &amp; GR USB drivers</b> window appears.            Ensure that all Leica Viva devices are disconnected from your PC before you continue!
5.	<b>Next&gt;</b> .
6.	The <b>Ready to Install the Program</b> window appears.
7.	<b>Install</b> . The drivers will be installed on your PC.            For PCs with Windows Vista or Windows 7/Windows 8 operating system: If not already installed, Windows Mobile Device Center will be installed additionally.
8.	The <b>InstallShield Wizard Completed</b> window appears.
9.	Check <b>I have read the instructions</b> and click <b>Finish</b> to exit the wizard.

### Connect USB cable to computer for the first time step-by-step

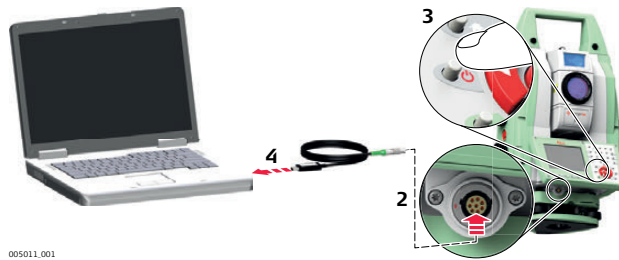



Step	Description
1.	Start the computer.
2.	Plug the GEV234 or GEV261 cable into the lemo-port on the instrument.
3.	Turn on the TPS instrument.
4.	Plug the GEV234 or GEV261 cable into the USB port of the computer. The <b>Found New Hardware Wizard</b> starts up automatically.
5.	Check <b>Yes, this time only. Next&gt;</b> .
6.	Check <b>Install the software automatically (Recommended). Next&gt;</b> . The software for <b>Remote NDIS based LGS TS Device</b> will be installed on your computer
7.	<b>Finish</b> .

Step	Description
8.	The <b>Found New Hardware Wizard</b> starts up automatically a second time.
9.	Check <b>Yes, this time only. Next&gt;</b> .
10.	Check <b>Install the software automatically (Recommended). Next&gt;</b> . The software for <b>LGS TS USB Device</b> will be installed on your computer.
11.	<b>Finish.</b>
	For PCs with Windows XP operating system:
12.	Run the ActiveSync installation program if not already installed.
13.	Allow USB connections inside the <b>Connection Settings</b> window of ActiveSync.
	For PCs with Windows Vista or Windows 7/Windows 8 operating system:
14.	Windows Mobile Device Center starts up automatically. If does not start automatically, start Windows Mobile Device Center.

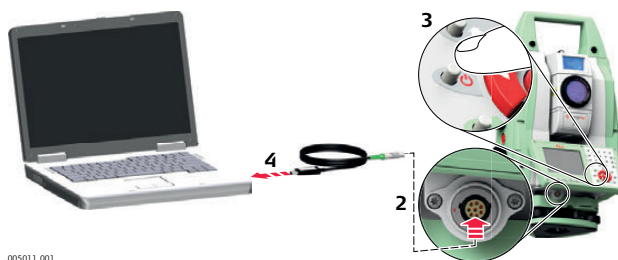
### Connect to computer via USB cable step-by-step





005011.001

Step	Description
1.	Start the PC.
2.	Plug the GEV234 or GEV261 cable into TS instrument.
3.	Turn on the TS instrument.
4.	Plug the GEV234 or GEV261 cable into the USB port of the computer.
	For PCs with Windows XP operating system:
	 ActiveSync starts up automatically. If does not start automatically, start ActiveSync. If not already installed, run the ActiveSync installation program.
5.	Allow USB connections inside the <b>Connection Settings</b> window of ActiveSync.
6.	Click <b>Explore</b> in ActiveSync.
	 The folders on the TS instrument are displayed under <b>Mobile Devices</b> . The folders of the data storage device can be found in either of the following folders:
	<ul style="list-style-type: none"> <li>• Leica Geosystems\SmartWorx Viva</li> <li>• <b>SD Card</b></li> <li>• <b>USB memory device</b></li> </ul>
	For PCs with Windows Vista or Windows 7/Windows 8 operating system:
	 Windows Mobile Device Center starts up automatically. If does not start automatically, start Windows Mobile Device Center.



## 4.3

## Power Functions



### Turning TS instrument on

Press and hold power key (  ) for 2 s.  
 TS Instrument must have a power supply.

### Turning TS instrument off

Press and hold power key (  ) for 5 s.  
 TS instrument must be on.  
 For instruments setup in permanent installations with external power sources, for example monitoring, ensure external power remains available until the instrument has successfully completed the power down process.

### Power Options menu

Press and hold power key (  ) for 2 s to open **Power Options** menu.  
 Instrument must be on.

Option	Description
<b>Turn off</b>	Turn TS instrument off.
<b>Stand-by</b>	Put TS instrument into stand-by mode.  In stand-by mode, the TS instrument shuts down and reduces power consumption. Rebooting from stand-by mode is quicker than a cold start after turning off.
<b>Lock keyboard</b>	Locks the keyboard. Option turns to <b>Unlock keyboard</b> .
<b>Turn off touch screen</b>	Disables touch screen. Option turns to <b>Turn on touch screen</b> .
<b>Reset...</b>	Performs one of the following options: <ul style="list-style-type: none"><li>• <b>Restart</b> (restarts Windows CE)</li><li>• <b>Reset Windows CE</b> (resets Windows CE and communication settings to factory defaults)</li><li>• <b>Reset installed software</b> (resets settings of all installed software)</li><li>• <b>Reset Windows CE and installed software</b> (resets Windows CE and settings of all installed software)</li></ul>



## 4.4

## Batteries

### 4.4.1

### Operating Principles

#### Charging / first-time use

- The battery must be charged prior to using it for the first time because it is delivered with an energy content as low as possible.
- The permissible temperature range for charging is between 0°C to +40°C/ +32°F to +104°F. For optimal charging, we recommend charging the batteries at a low ambient temperature of +10°C to +20°C/+50°F to +68°F if possible.
- It is normal for the battery to become warm during charging. Using the chargers recommended by Leica Geosystems, it is not possible to charge the battery if the temperature is too high.
- For new batteries or batteries that have been stored for a long time (> three months), it is effectual to make only one charge/discharge cycle.
- For Li-Ion batteries, a single discharging and charging cycle is sufficient. We recommend carrying out the process when the battery capacity indicated on the charger or on a Leica Geosystems product deviates significantly from the actual battery capacity available.

#### Operation / Discharging

- The batteries can be operated from -20°C to +55°C/-4°F to +131°F.
- Low operating temperatures reduce the capacity that can be drawn; high operating temperatures reduce the service life of the battery.

### 4.4.2

### Battery for the TS Instrument

#### Change battery step-by-step

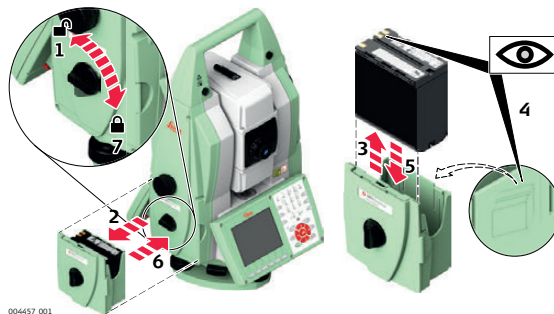

Step	Description
1.	Face the instrument so that the vertical drive screw is on the left. The battery compartment is below the vertical drive. Turn the knob to the vertical position, opening the lid of the battery compartment.
2.	Pull out the battery housing.
3.	Pull the battery from the battery housing.
4.	A pictogram of the battery is displayed at the backside of the battery housing. This pictogram is a visual aid to assist in placing the battery correctly.
5.	Place the battery into the battery housing, ensuring that the contacts are facing outward. Click the battery into position.
6.	Place the battery housing into the battery compartment. Push the battery housing in until it fits completely into the battery compartment.
7.	Turn the knob to lock the battery compartment. Ensure that the knob is returned to its original horizontal position.

### 4.4.3

### Battery for SmartAntenna

#### Change battery step-by-step (GS15)

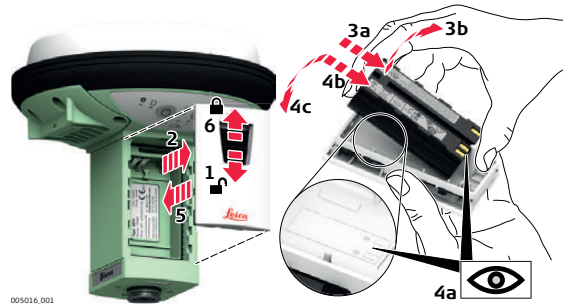

Step	Description
	The batteries are inserted in the bottom part of the instrument.
1.	Push the slide fastener of one of the battery compartments in the direction of the arrow with the open-lock symbol.
2.	Remove the cover from the battery compartment.
3.	With the battery contacts facing upwards, slide the battery into the cover of the battery compartment.
4.	Push the battery upwards so that it locks into position.
5.	Insert the cover of the battery compartment into the compartment.
6.	Push the slide fastener in the direction of the arrow with the close-lock symbol.

#### Change battery step-by-step (GS14)

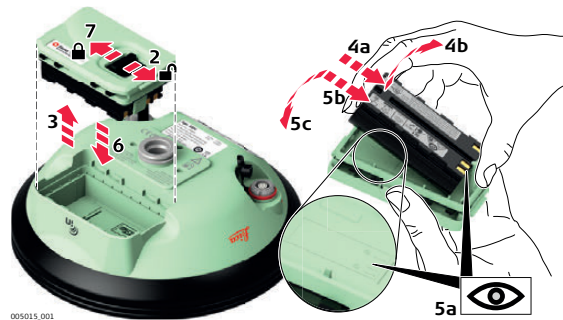

Step	Description
1.	The battery is inserted in the bottom part of the instrument.
2.	Push the slide fastener of the battery compartment in the direction of the arrow with the open-lock symbol.
3.	Remove the cover from the battery compartment.
4.	Push the battery slightly upwards and at the same time pull out the bottom part of the battery. This releases the battery from its fixed position.
5.	With the battery contacts facing upwards, slide the battery into the cover of the battery compartment. Push the battery upwards so that it locks into position.
6.	Insert the cover of the battery compartment into the compartment.
7.	Push the slide fastener in the direction of the arrow with the close-lock symbol.

## 4.5

## Working with the Memory Device



- Keep the card dry.
- Use it only within the specified temperature range.
- Do not bend the card.
- Protect the card from direct impacts.



Failure to follow these instructions could result in data loss and/or permanent damage to the card.

### Insert and remove an SD card step-by-step

Step	Description	
	The SD card is inserted into a slot inside the Communication side cover of the instrument.	
1.	Press the button on the side of the Communication side cover to unlock the communication compartment.	
	The lid opens automatically.	
2.	Slide the SD card firmly into the SD slot until it clicks into position. <ul style="list-style-type: none"> <li> The card must be held with the contacts at the top and facing toward the instrument.</li> <li> Do not force the card into the slot.</li> </ul>	
3.	Close the lid by pushing the door down. Push the door on the marked part in the middle of the door.	
4.	To remove the SD card, open the lid of the communication compartment and gently press on the top of the card to release it from the slot.	

### Insert and remove a USB stick step-by-step

Step	Description	
	The USB stick is inserted into the USB host port inside the Communication side cover of the instrument.	
1.	Press the button on the side of the Communication side cover to unlock the communication compartment.	
	The lid opens automatically.	
2.	Slide the USB stick with the Leica logo facing you firmly into the USB host port until it clicks into position. <ul style="list-style-type: none"> <li> Do not force the USB stick into the port.</li> </ul>	
3.	Close the lid by pushing the door down. Push the door on the marked part in the middle of the door.	
4.	To remove the USB stick, open the lid of the compartment and slide the USB stick out of the port.	

## Insert a microSD card into GS14 step-by-step

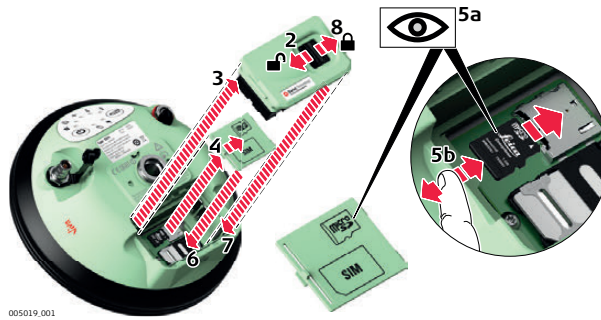

Step	Description
	Removing the microSD card while the GS14 is turned on can cause loss of data. Only remove the microSD card or unplug connecting cables when the GS14 is switched off.
1.	The microSD card is inserted into a slot inside the battery compartment of the instrument.
2.	Push the slide fastener of the battery compartment in the direction of the arrow with the open-lock symbol.
3.	Remove the cover from the battery compartment.
4.	Press the latch of the SIM/microSD card cover and remove the cover.
5.	Slide the microSD card with the logo facing upwards firmly into the slot until it clicks into position.
6.	Insert the SIM/microSD card cover to cover slot.
7.	Insert the cover over the battery compartment.
8.	Push the slide fastener in the direction of the arrow with the close-lock symbol.

## Insert and remove an SD card into GS15 step-by-step

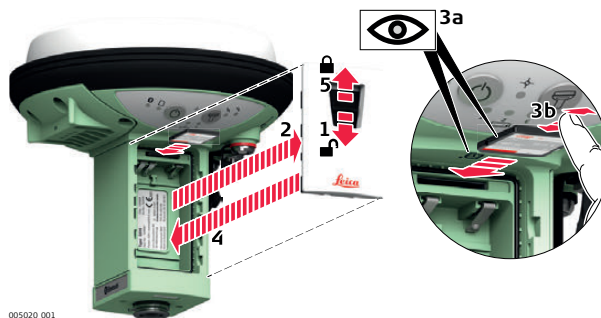

Step	Description
	The SD card is inserted into a slot inside the battery compartment 1 of the instrument.
1.	Push the slide fastener of battery compartment 1 in the direction of the arrow with the open-lock symbol.
2.	Remove the cover from battery compartment 1.
3.	Slide the card firmly into the slot until it clicks into position.
	Do not force the card into the slot. The card should be held with the contacts upwards and facing the slot.
	To remove the card, push the slide fastener of battery compartment 1 in the direction of the arrow with the open-lock symbol and remove the cover. Gently press on the top of the card to release it from the slot. Remove the SD card.

Step	Description
4.	Insert the cover into battery compartment 1.
5.	Push the slide fastener in the direction of the arrow with the close-lock symbol.

## 4.6

## LED Indicators

### LED indicators

#### Description

The GS08plus/GS12 instrument has **Light Emitting Diode** indicators. They indicate the basic instrument status.

#### Diagram

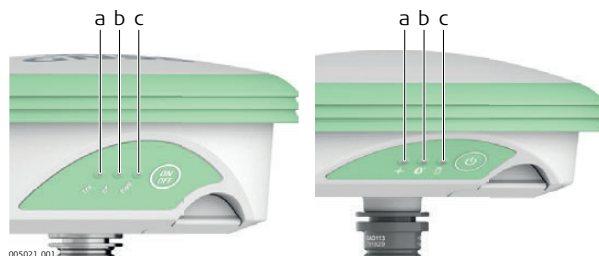

- a) Tracking LED (TRK)
- b) Bluetooth LED (BT)
- c) Power LED (PWR)

#### Description of the LEDs

IF the	is	THEN
TRK LED	off	No satellites are tracked.
	flashing green	Less than four satellites are tracked, a position is not yet available.
	green	Enough satellites are tracked to compute a position.
	red	GS08plus/GS12 instrument is initialising.
BT LED	green	Bluetooth is in data mode and ready for connecting.
	purple	Bluetooth is connecting.
	blue	Bluetooth has connected.
	flashing blue	Data is being transferred.
GS12 PWR LED	off	Power is off.
	green	Power is okay.
	flashing green	Power is low. The remaining time for which enough power is available depends on the type of survey, the temperature and the age of the battery.
GS08plus PWR LED	off	Power is off.
	green	Power is 100% - 20%.
	red	Power is 20% - 5%.
	flashing red	Power is low (< 5%). The remaining time for which enough power is available depends on the type of survey, the temperature and the age of the battery.

## LED indicators

### Description

The GS14 GNSS instrument has **L**ight **E**mitting **D**iode indicators. They indicate the basic instrument status.

### Diagram

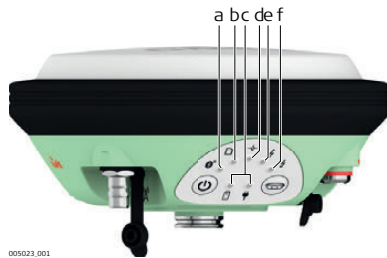

- a) Bluetooth LED
- b) Storage LED
- c) Power LEDs
- d) Position LED
- e) RTK Base LED
- f) RTK Rover LED

## LED indicators on GS15

### Description

The GS15 has **L**ight **E**mitting **D**iode indicators. They indicate the basic instrument status.

### Diagram

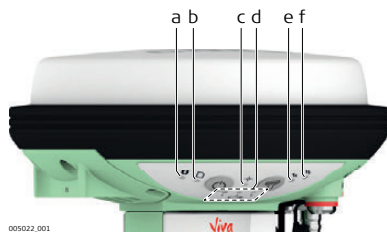

- a) Bluetooth LED
- b) Storage LED
- c) Position LED
- d) Power LEDs
- e) RTK Base LED
- f) RTK Rover LED

### Description of the LEDs

IF the	is	THEN
Bluetooth LED	green	Bluetooth is in data mode and ready for connecting.
	purple	Bluetooth is connecting.
	blue	Bluetooth has connected.
Storage LED	off	no SD card is inserted or GS15 is switched off.
	green	SD card is inserted but no raw data is being logged.
	flashing green	raw data is being logged.
	flashing yellow	raw data is being logged but only 10% memory left.
	flashing red	raw data is being logged but only 5% memory left.
	red	SD card is full, no raw data is being logged.
	fast flashing red	no SD card is inserted but GS15 is configured to log raw data.
Position LED	off	no satellites are tracked or GS15 is switched off.
	flashing yellow	less than four satellites are tracked, a position is not yet available.
	yellow	a navigated position is available.
	flashing green	a code-only position is available.

IF the	is	THEN
	green	a fixed RTK position is available.
Power LED (active battery <sup>*1</sup> )	off	battery is not connected, flat or GS15 is switched off.
	green	power is 40% - 100%.
	yellow	power is 20% - 40%. The remaining time for which enough power is available depends on the type of survey, the temperature and the age of the battery.
	red	power is 5% - 20%.
	fast flashing red	power is low (<5%).
Power LED (passive battery <sup>*2</sup> )	off	battery is not connected, flat or the GS15 is switched off.
	flashing green	power is 40% - 100%. LED is green for 1 s every 10 s.
	flashing yellow	power is 20% - 40%. LED is yellow for 1 s every 10 s.
	flashing red	power is less than 20%. LED is red for 1 s every 10 s.
RTK Rover LED	off	GS15 is in RTK base mode or GS15 is switched off.
	green	GS15 is in rover mode. No RTK data is being received at the interface of the communication device.
	flashing green	GS15 is in rover mode. RTK data is being received at the interface of the communication device.
RTK Base LED	off	GS15 is in RTK rover mode or GS15 is switched off.
	green	GS15 is in RTK base mode. No RTK data is being passed to the RX/TX interface of the communication device.
	flashing green	GS15 is in RTK base mode. Data is being passed to the RX/TX interface of the communication device.

\*1 The battery, which currently powers the GS15 GNSS instrument.

\*2 Other batteries, which are inserted or connected but are not currently power the GS15 GNSS instrument.

## LED Indicators on RadioHandle

### Description

The RadioHandle has **L**ight **E**mitting **D**iode indicators. They indicate the basic RadioHandle status.

## Diagram of the LED Indicators

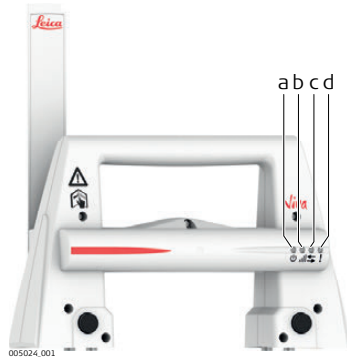

- a) Power LED
- b) Link LED
- c) Data Transfer LED
- d) Mode LED

## Description of the LED Indicators

IF the	is	THEN
Power LED	off	power is off.
	green	power is on.
Link LED	off	no radio link to field controller.
	red	radio link to field controller.
Data Transfer LED	off	no data transfer to/from field controller.
	green or green flashing	data transfer to/from field controller.
Mode LED	off	data mode.
	red	configuration mode.

## 4.7

## Guidelines for Correct Results

### Distance measurement

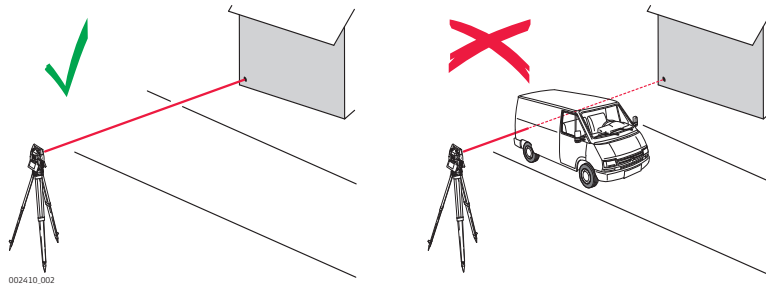

When measurements are being made using the red laser EDM, the results can be influenced by objects passing between the EDM and the intended target surface. This occurs because reflectorless measurements are made to the first surface returning sufficient energy to allow the measurement to take place. For example, if the intended target surface is the surface of a building, but a vehicle passes between the EDM and the target surface as the measurement is triggered, the measurement may be made to the side of the vehicle. The result is the distance to the vehicle, not to the surface of the building.

If using the long range measurement mode (> 1000 m, > 3300 ft, available on TS50/TM50) to prisms, and an object passes within 30 m of the EDM as the measurement is triggered, the distance measurement may be similarly effected due to the strength of the laser signal.



Very short distances can also be measured reflectorless in **Prism** mode to well reflecting natural targets. The distances are corrected with the additive constant defined for the active reflector.





## CAUTION

Due to laser safety regulations and measuring accuracy, using the Long Range Reflectorless EDM is only allowed to prisms that are more than 1000 m (3300 ft) away.

---



Accurate measurements to prisms should be made in **Prism** mode.

---



When a distance measurement is triggered, the EDM measures to the object which is in the beam path at that moment. If a temporary obstruction, for example a passing vehicle, heavy rain, fog or snow is between the instrument and the point to be measured, the EDM may measure to the obstruction.

---



Do not measure with two instruments to the same target simultaneously to avoid getting mixed return signals.

---

## ATR/lock

Instruments equipped with an ATR sensor permit automatic angle and distance measurements to prisms. The prism is sighted with the optical sight. After initiating a distance measurement, the instrument sights the prism centre automatically. Vertical and horizontal angles and the distance are measured to the centre of the prism. The lock mode enables the instrument to follow a moving prism.

---



As with all other instrument errors, the collimation error of the automatic aiming must be redetermined periodically. Refer to "5 Check & Adjust" about checking and adjusting instruments.

---



When a measurement is triggered while the prism is still moving, distance and angle measurements may not be made for the same position and coordinates may vary.

---



If the prism location is changed too quickly, the target may be lost. Make sure that the speed does not exceed the figure given in the technical data.

---

## Motorised Positioning

Unstable instrument setup conditions or small vibrations of the instrument resulting from heavy traffic or construction activities in the vicinity of the instrument may lead to an abandonment of the instrument's positioning before the final position is reached. Ensure that the instrument setup is stable, especially if steep sightings are necessary. If an incomplete positioning is indicated check the position deviation and repeat the according positioning command.

---

# 5 Check & Adjust

## 5.1 Overview

---

<b>Description</b>	<p>Leica Geosystems instruments are manufactured, assembled and adjusted to the best possible quality. Quick temperature changes, shock or stress can cause deviations and decrease the instrument accuracy. It is therefore recommended to check and adjust the instrument from time to time. This check and adjust can be done in the field by running through specific measurement procedures. The procedures are guided and must be followed carefully and precisely as described in the following chapters. Some other instrument errors and mechanical parts can be adjusted mechanically.</p>												
<b>Electronic adjustment</b>	<p>The following instrument errors can be checked and adjusted electronically:</p> <table><tr><td>l, t</td><td>Compensator longitudinal and transversal index errors</td></tr><tr><td>i</td><td>Vertical index error, related to the standing axis</td></tr><tr><td>c</td><td>Horizontal collimation error, also called line of sight error</td></tr><tr><td>a</td><td>Tilting axis error</td></tr><tr><td>ATR</td><td>ATR zero point error for Hz and V - option</td></tr><tr><td>Co-axial camera</td><td>Co-axial camera zero point error, relation between principal point of co-axial camera and crosshair in telescope in Hz and V - option</td></tr></table> <p>If the compensator and the horizontal corrections are activated in the instrument configuration, every angle measured in the daily work is corrected automatically . Select <b>Main Menu: Instrument\TPS settings\Level bubble &amp; compensator</b> to check whether the tilt correction and the horizontal correction are turned on. The results are displayed as errors but used with the opposite sign as corrections when applied to measurements.</p>	l, t	Compensator longitudinal and transversal index errors	i	Vertical index error, related to the standing axis	c	Horizontal collimation error, also called line of sight error	a	Tilting axis error	ATR	ATR zero point error for Hz and V - option	Co-axial camera	Co-axial camera zero point error, relation between principal point of co-axial camera and crosshair in telescope in Hz and V - option
l, t	Compensator longitudinal and transversal index errors												
i	Vertical index error, related to the standing axis												
c	Horizontal collimation error, also called line of sight error												
a	Tilting axis error												
ATR	ATR zero point error for Hz and V - option												
Co-axial camera	Co-axial camera zero point error, relation between principal point of co-axial camera and crosshair in telescope in Hz and V - option												
<b>View current adjustment errors</b>	<p>To view the adjustment errors currently used, select <b>Main Menu: User\Check &amp; Adjust</b> to open the <b>Check &amp; Adjust Wizard</b>. Select the option <b>View the current values</b>.</p>												
<b>Mechanical adjustment</b>	<p>The following instrument parts can be adjusted mechanically:</p> <ul style="list-style-type: none"><li>• Circular level on instrument and tribrach</li><li>• Optical plummet - option on tribrach</li><li>• Allen screws on tripod</li></ul>												
<b>Precise measurements</b>	<p>To get precise measurements in the daily work, it is important:</p> <ul style="list-style-type: none"><li>• To check and adjust the instrument from time to time.</li><li>• To take high precision measurements during the check and adjust procedures.</li><li>• To measure targets in two faces. Some of the instrument errors are eliminated by averaging the angles from both faces.</li></ul>												
	<p>During the manufacturing process, the instrument errors are carefully determined and set to zero. As mentioned above, these errors can change and it is highly recommended to redetermine them in the following situations:</p> <ul style="list-style-type: none"><li>• Before the first use</li><li>• Before every high precision survey</li><li>• After rough or long transportation</li><li>• After long working periods</li><li>• After long storage periods</li><li>• If the temperature difference between current environment and the temperature at the last calibration is more than 20°C</li></ul>												

---

**Summary of errors to be adjusted electronically**

Instrument error	Effects Hz	Effects V	Elimination with two face measurement	Automatically corrected with proper adjustment
c - Line of sight error	✓	-	✓	✓
a - Tilting axis error	✓	-	✓	✓
l - Compensator index error	-	✓	✓	✓
t - Compensator index error	✓	-	✓	✓
i - Vertical index error	-	✓	✓	✓
ATR Collimation error	✓	✓	-	✓
Co-axial camera collimation error	✓	✓	✓	✓

**5.2**

**Preparation**



Before determining the instrument errors, the instrument has to be levelled using the electronic level. Select **Main Menu: Instrument\TPS settings\Level bubble & compensator** to access the **Level Bubble & Compensator** screen.

The tribrach, the tripod and the underground should be stable and secure from vibrations or other disturbances.



The instrument should be protected from direct sunlight to avoid thermal warming.

It is also recommended to avoid strong heat shimmer and air turbulence. The best conditions are early in the morning or with overcast sky.



Before starting to work, the instrument has to become acclimatised to the ambient temperature. Approximately two minutes per °C of temperature difference from storage to working environment, but at least 15 min, should be taken into account.



Even after adjustment of the ATR, the crosshairs may not be positioned exactly on the centre of the prism after an ATR measurement has been completed. This outcome is a normal effect. The telescope is not normally positioned exactly on the centre of the prism, to speed up the ATR measurement. These small deviations/ATR offsets, are calculated individually for each measurement and corrected electronically. This means that the horizontal and vertical angles are corrected twice: first by the determined ATR errors for Hz and V, and then by the individual small deviations of the current aiming.

**Next step**

IF the task is to	THEN
adjust a combination of instrument errors	Refer to "5.3 Combined Adjustment (l, t, i, c, ATR and tele camera)".
adjust the tilting axis	Refer to "5.4 Tilting Axis Adjustment (a)".
adjust the circular level	Refer to "5.5 Adjusting the Circular Level of the Instrument and Tribrach".
adjust the laser/optical plummet	Refer to "5.7 Inspecting the Laser Plummet of the Instrument".
adjust the tripod	Refer to "5.8 Servicing the Tripod".





**Description**



The combined adjustment procedure determines the following instrument errors in one process:

l, t	Compensator longitudinal and transversal index errors
i	Vertical index error, related to the standing axis
c	Horizontal collimation error, also called line of sight error
ATR Hz	ATR zero point error for horizontal angle - option
ATR V	ATR zero point error for vertical angle - option
Co-axial camera Hz	Co-axial camera zero point error for horizontal angle - option
Co-axial camera V	Co-axial camera zero point error for vertical angle - option

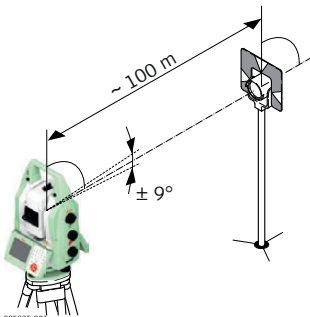
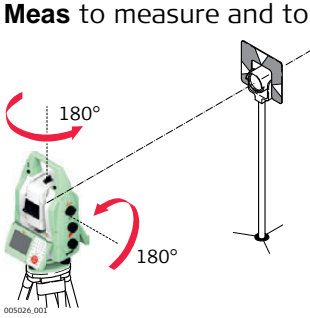
**Combined adjustment procedure step-by-step**

The following table explains the most common settings.

Step	Description
1.	<b>Main Menu: User\Check &amp; Adjust</b>
2.	<b>Check &amp; Adjust Wizard</b> Select the option: <b>Check &amp; adjust the compensator, index error, line of sight error, automatic target aiming &amp; telescope camera</b>
3.	<b>Next</b>
4.	<b>Face I measurement</b> If <b>Calibrate the automatic target aiming</b> is checked and an ATR is available, the adjustment will include the determination of the ATR Hz and V adjustment errors.  Use a clean Leica standard prism as the target. Do not use a 360° prism.  If <b>Calibrate the telescope camera</b> is checked and a telescope camera is available, the adjustment includes the determination of the telescope camera zero point.  Use a clean Leica standard prism as the target. Do not use a 360° prism.
5.	 Aim the telescope accurately at a target at about 100 m distant. The target must be positioned within $\pm 9^\circ/\pm 10$ gon of the horizontal plane. The procedure can be started in any face.
6.	<b>Meas</b> to measure and to continue to the next screen.  If <b>Calibrate the telescope camera</b> has been checked, aim at the same target accurately with the telescope camera using the view finder and the digital crosshair on the display. <b>Meas</b> to measure and to continue to the next screen.   The fine pointing has to be performed manually in both faces.
7.	<b>Face II measurement</b>

Step	Description
	<p><b>Meas</b> to measure the same target in the other face.</p> <p>If <b>Calibrate the telescope camera</b> has been checked, aim at the same target accurately with the telescope camera using the view finder and the digital crosshair on the display. <b>Meas</b> measure to the target and to calculate the instrument errors.</p>
	If one or more errors are bigger than the predefined limits, the procedure must be repeated. All measurements of the current run are rejected and none of them is averaged with the results from previous runs.
8.	<p>Adjustment Status</p> <p><b>No. of measurements:</b> Shows the number of runs completed. One run consists of a measurement in face I and face II.</p> <p><b><math>\sigma</math> I Comp:</b> and similar lines show the standard deviations of the determined adjustment errors. The standard deviations can be calculated from the second run onwards.</p>
	Measure at least two runs.
9.	<b>Next</b> to continue with the check & adjust procedure.
10.	<p>Select <b>Add another calibration loop</b> if more runs have to be added. <b>Next</b> and continue with step 4.</p> <p>OR</p> <p>Select <b>Finish the calibration &amp; store the results</b> to finish the calibration process. <b>Next</b> to view the adjustment results.</p>
11.	<p>Select <b>Finish</b> to accept the results. No more runs can be added later.</p> <p>OR</p> <p>Select <b>Redo</b> to decline all measurements and to repeat all calibration runs.</p> <p>OR</p> <p><b>Back</b> returns to the previous screen.</p>

#### Next step

IF the results are	THEN
to be stored	If the Use status is set to Yes, <b>Next</b> overwrites the old adjustment errors with the new ones.
to be determined again	<b>Redo</b> rejects all new determined adjustment errors and repeats the whole procedure. Refer to paragraph "Combined adjustment procedure step-by-step".

## 5.4 Tilting Axis Adjustment (a)

### Description

This adjustment procedure determines the following instrument error:

a Tilting axis error

### Determination of tilting axis error step-by-step

The following table explains the most common settings.

Step	Description
	Determine the horizontal collimation error (c) before starting this procedure.
1.	<b>Main Menu: User\Check &amp; Adjust</b>
2.	<b>Check &amp; Adjust Wizard</b>

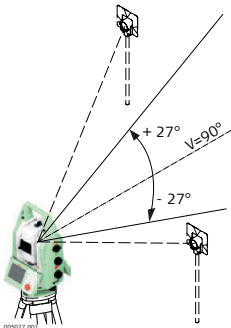
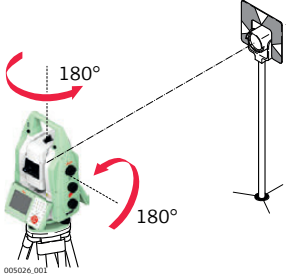
Step	Description
	Select the option: <b>Check &amp; adjust the tilting axis</b>
3.	<p><b>Face I measurement</b></p>  <p>Aim the telescope accurately at a target at about 100 m distance or less if not possible. The target must be positioned at least 27°/30 gon above or beneath the horizontal plane. The procedure can be started in any telescope face.</p>
4.	 <p><b>Meas</b> to measure and to continue to the next screen. ☞ The fine pointing must be performed manually in both faces.</p>
5.	<p><b>Face II measurement</b></p> <p><b>Meas</b> to measure the same target in the other face and to calculate the tilting axis error.</p>
☞	If the error is bigger than the predefined limit, the procedure must be repeated. The tilting axis measurements of the current run are then rejected and not averaged with the results from previous runs.
6.	<p>Adjustment Status</p> <p><b>No. of measurements:</b> Shows the number of runs completed. One run consists of a measurement in face I and face II.</p> <p><b><math>\sigma</math> a T-axis:</b> shows the standard deviation of the determined tilting axis error. The standard deviation can be calculated from the second run onwards.</p>
☞	Measure at least two runs.
7.	<b>Next</b> to continue with the check & adjust procedure.
8.	<p>Select <b>Add another calibration loop</b> if more runs have to be added. <b>Next</b> and continue with step 3.</p> <p>OR</p> <p>Select <b>Finish the calibration &amp; store the results</b> to finish the calibration process. No more runs can be added later. <b>Next</b> to view the adjustment results.</p>
9.	<p>Select <b>Finish</b> to accept the results. No more runs can be added later.</p> <p>OR</p> <p>Select <b>Redo</b> to decline all measurements and to repeat all calibration runs.</p>

### Next step

IF the results are	THEN
to be stored	<b>Next</b> overwrites the old tilting axis error with the new one.
to be determined again	<b>Redo</b> rejects the new determined tilting axis error and repeats the whole procedure. Refer to paragraph "Tilting Axis Adjustment (a)".

## 5.5

## Adjusting the Circular Level of the Instrument and Tribrach

### Adjusting the circular level step-by-step

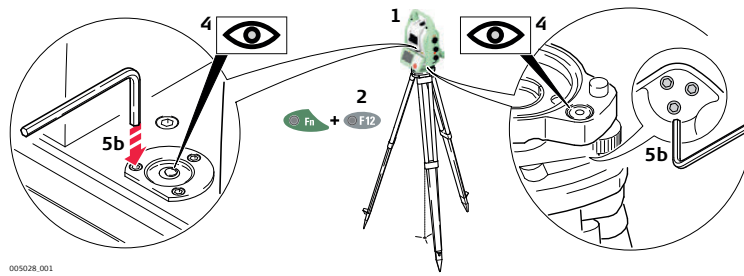

Step	Description
1.	Place and secure the instrument into the tribrach and onto a tripod.
2.	Using the tribrach footscrews, level the instrument with the electronic level.
3.	Select <b>Instrument\TPS settings\Level bubble &amp; compensator</b> to access the <b>Level Bubble &amp; Compensator</b> screen.
4.	Check the position of the circular level on the instrument and tribrach.
5.	a) If both circular levels are centred, no adjustments are necessary
	b) If one or both circular levels are not centred, adjust as follows:
	<b>Instrument:</b> If it extends beyond the circle, use the supplied allen key to centre it with the adjustment screws. Turn the instrument by 200 gon (180°). Repeat the adjustment procedure if the circular level does not stay centred.
	<b>Tribrach:</b> If it extends beyond the circle, use the supplied allen key to centre it with the adjustment screws.
	After the adjustments, all adjusting screws must have the same tightening tension and no adjusting screw should be loose.

## 5.6

## Adjusting the Circular Level of the Prism Pole

### Adjusting the circular level step-by-step

Step	Description
1.	Suspend a plumb line.
2.	Use a pole bipod, to align the prism pole parallel to the plumb line.
3.	Check the position of the circular level on the prism pole.
4.	a) If the circular level is centred, no adjustment is necessary.
	b) If the circular level is not centred, use an allen key to centre it with the adjustment screws.
	After the adjustments, all adjusting screws must have the same tightening tension and no adjusting screw should be loose.

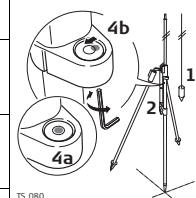

## 5.7

## Inspecting the Laser Plummet of the Instrument



The laser plummet is located in the vertical axis of the instrument. Under normal conditions of use, the laser plummet does not need adjusting. If an adjustment is necessary due to external influences, return the instrument to any Leica Geosystems authorised service workshop.

## Inspecting the laser plummet step-by-step

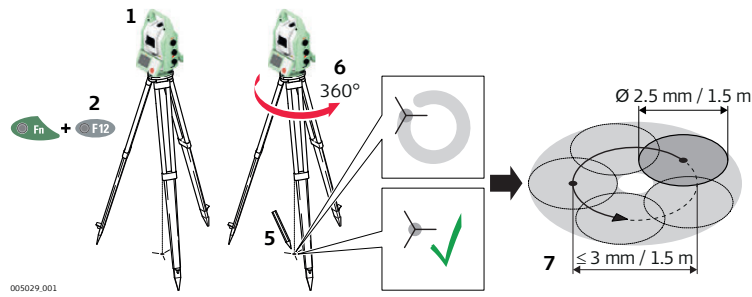

The following table explains the most common settings.

Step	Description
1.	Place and secure the instrument into the tribrach and onto a tripod.
2.	Using the tribrach footscrews, level the instrument with the electronic level.
3.	Select <b>Instrument\TPS settings\Level bubble &amp; compensator</b> to access the <b>Level Bubble &amp; Compensator</b> screen.
4.	The laser plummet is switched on when the <b>Level Bubble &amp; Compensator</b> screen is entered. Adjust the laser plummet intensity. Inspection of the laser plummet should be carried out on a bright, smooth and horizontal surface, like a sheet of paper.
5.	Mark the centre of the red dot on the ground.
6.	Turn the instrument through 360° slowly, carefully observing the movement of the red laser dot.
	The maximum diameter of the circular movement described by the centre of the laser point must not exceed 3 mm at a distance of 1.5 m.
7.	If the centre of the laser dot describes a perceptible circular movement, or moves more than 3 mm away from the point which was first marked, an adjustment may be required. Inform your nearest Leica Geosystems authorised service workshop. Depending on brightness and surface, the diameter of the laser dot can vary. At 1.5 m, it is about 2.5 mm.

## 5.8

### Servicing the Tripod

#### Servicing the tripod step-by-step

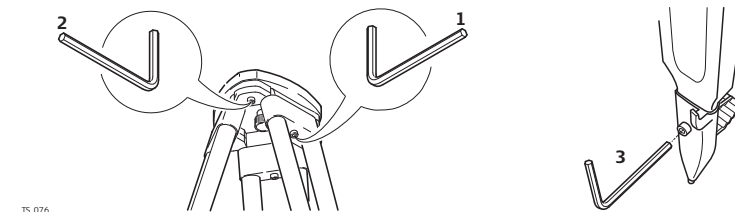

The following table explains the most common settings.

Step	Description
	The connections between metal and timber components must always be firm and tight.
1.	Tighten the leg cap screws moderately, with the supplied allen key.
2.	Tighten the articulated joints on the tripod head enough to keep the tripod legs open when lifting the tripod off the ground.
3.	Tighten the allen screws of the tripod legs.



## 6 Care and Transport

### 6.1 Transport

---

<b>Transport in the field</b>	When transporting the equipment in the field, always make sure that you <ul style="list-style-type: none"><li>• either carry the product in its original transport container,</li><li>• or carry the tripod with its legs splayed across your shoulder, keeping the attached product upright.</li></ul>
<b>Transport in a road vehicle</b>	Never carry the product loose in a road vehicle, as it can be affected by shock and vibration. Always carry the product in its transport container and secure it.
<b>Shipping</b>	When transporting the product by rail, air or sea, always use the complete original Leica Geosystems packaging, transport container and cardboard box, or its equivalent, to protect against shock and vibration.
<b>Shipping, transport of batteries</b>	When transporting or shipping batteries, the person in charge of the product must ensure that the applicable national and international rules and regulations are observed. Before transportation or shipping, contact your local passenger or freight transport company.
<b>Field adjustment</b>	Periodically carry out test measurements and perform the field adjustments indicated in the User Manual, particularly after the product has been dropped, stored for long periods or transported.

---

### 6.2 Storage

---

<b>Product</b>	Respect the temperature limits when storing the equipment, particularly in summer if the equipment is inside a vehicle. Refer to "7 Technical Data" for information about temperature limits.
<b>Field adjustment</b>	After long periods of storage inspect the field adjustment parameters given in this user manual before using the product.
<b>Li-Ion batteries</b>	<ul style="list-style-type: none"><li>• Refer to "7 Technical Data" for information about storage temperature range.</li><li>• Remove batteries from the product and the charger before storing.</li><li>• After storage recharge batteries before using.</li><li>• Protect batteries from damp and wetness. Wet or damp batteries must be dried before storing or use.</li><li>• A storage temperature range of 0°C to +30°C / +32°F to +86°F in a dry environment is recommended to minimize self-discharging of the battery.</li><li>• At the recommended storage temperature range, batteries containing a 40% to 50% charge can be stored for up to one year. After this storage period the batteries must be recharged.</li></ul>

---

### 6.3 Cleaning and Drying

---

<b>Product and accessories</b>	<ul style="list-style-type: none"><li>• Blow dust off lenses and prisms.</li><li>• Never touch the glass with your fingers.</li><li>• Use only a clean, soft, lint-free cloth for cleaning. If necessary, moisten the cloth with water or pure alcohol. Do not use other liquids; these can attack the polymer components.</li></ul>
--------------------------------	--

---

### Fogging of prisms

Prisms that are cooler than the ambient temperature tend to fog. It is not enough simply to wipe them. Keep them for some time inside your jacket or in the vehicle to allow them to adjust to the ambient temperature.

---

### Damp products

Dry the product, the transport container, the foam inserts and the accessories at a temperature not greater than 40°C /104°F and clean them. Remove the battery cover and dry the battery compartment. Do not repack until everything is completely dry. Always close the transport container when using in the field.

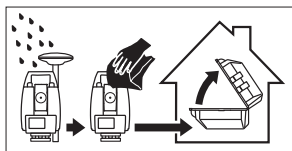

### Cables and plugs

Keep plugs clean and dry. Blow away any dirt lodged in the plugs of the connecting cables.

---

## 6.4

### Maintenance

---



An inspection of the product must be done in a Leica Geosystems authorised service workshop. Leica Geosystems recommends an inspection of the product every 12 months.

As MS50/TS50/TM50 instruments are equipped with a self-surveillance system designed for maximum motor performance and long maintenance cycles Leica Geosystems recommends inspection of the product whenever indicated in the message line of the user interface.

---

# 7 Technical Data

## 7.1 Angle Measurement

### Accuracy

Type	std. dev. Hz, V, ISO 17123-3		Display least count	
	["]	[mgon]	["]	[mgon]
TM50 R1000/ TM50 I R1000	0.5	0.15	0.1	0.01
	1	0.30	0.1	0.01
TS50 I R1000	0.5	0.15	0.1	0.01
MS50 R2000	1	0.30	0.1	0.01

### Characteristics

Absolute, continuous, diametric.

## 7.2 Distance Measurement with Reflectors

### Range

For TS50/TM50 - R1000:

Reflector	Range A		Range B		Range C	
	[m]	[ft]	[m]	[ft]	[m]	[ft]
Standard prism (GPR1, GPH1P)	1800	6000	3000	10000	3500	12000
360° prism (GRZ4, GRZ122)	800	2600	1500	5000	2000	7000
360° Mini prism (GRZ101)	450	1500	800	2600	1000	3300
Mini prism (GMP101)	800	2600	1200	4000	2000	7000
Reflector tape (GZM31) 60 mm x 60 mm	150	500	250	800	250	800
Machine Automation power prism (MPR122)	800	2600	1500	5000	2000	7000

 For Machine Control purposes only!

Shortest measuring distance: 1.5 m

For MS50 - R2000:

Reflector	Range A		Range B		Range C	
	[m]	[ft]	[m]	[ft]	[m]	[ft]
Standard prism (GPR1, GPH1P)	2200	7300	7500	24600	>10000	>32800
360° prism (GRZ4, GRZ122)	1200	3900	2250	7500	3000	10500
360° Mini prism (GRZ101)	670	2250	1200	3900	1500	4950
Mini prism (GMP101)	1200	3900	1800	6000	3000	10500
Reflector tape (GZM31) 60 mm x 60 mm	220	750	375	1200	370	1200
Machine Automation power prism (MPR122)	1200	3900	2250	7500	3000	10500

 For Machine Control purposes only!

Shortest measuring distance: 1.5 m

## Atmospheric conditions

Range A: Strong haze, visibility 5 km; or strong sunlight, severe heat shimmer  
Range B: Light haze, visibility about 20 km; or moderate sunlight, slight heat shimmer  
Range C: Overcast, no haze, visibility about 40 km; no heat shimmer



Measurements can be made to reflector tapes over the entire range without external ancillary optics.

## Accuracy

Accuracy refers to measurements to standard prisms.

For TS50/TM50 - R1000:

EDM measuring mode	std. dev. ISO 17123-4, standard prism	std. dev. ISO 17123-4, tape**	Measurement time, typical [s]
Precise	0.6 mm + 1 ppm*	1 mm + 1 ppm	7
Standard	1 mm + 1 ppm	1 mm + 1 ppm	2.4
Fast	2 mm + 1 ppm	3 mm + 1 ppm	2.0
Continuous	2 mm + 1 ppm	3 mm + 1 ppm	< 0.15
Averaging	1 mm + 1 ppm	1 mm + 1 ppm	-
Continuous+	2 mm + 1 ppm	3 mm + 1 ppm	< 0.15

Beam interruptions, severe heat shimmer and moving objects within the beam path can result in deviations of the specified accuracy.

\* Atmospheric conditions type C, range up to 1000 m, GPH1P reflector

\*\* Target aligned to instrument

For MS50 - R2000:

EDM measuring mode	std. dev. ISO 17123-4, standard prism	std. dev. ISO 17123-4, tape*	Measurement time, typical [s]
Standard	1 mm + 1.5 ppm	1 mm + 1.5 ppm	1.5
Fast	2 mm + 1.5 ppm	3 mm + 1.5 ppm	0.5
Continuous	2 mm + 1.5 ppm	3 mm + 1.5 ppm	>0.05**
Averaging	1 mm + 1.5 ppm	1 mm + 1.5 ppm	-
Continuous+	2 mm + 1.5 ppm	3 mm + 1.5 ppm	>0.05**

Beam interruptions, severe heat shimmer and moving objects within the beam path can result in deviations of the specified accuracy.

\* Target aligned to instrument

\*\* Auto point application increases the measurement time

## Characteristics

Type: Coaxial, visible red laser  
Carrier wave: 658 nm  
Measuring system: R1000: System analyser basis 100 MHz - 150 MHz  
R2000: Wave Form Digitizer

## 7.3

## Distance Measurement without Reflectors

### Range

Type	Kodak Gray Card	Range D		Range E		Range F	
		[m]	[ft]	[m]	[ft]	[m]	[ft]
R1000	White side, 90 % reflective	800	2630	1000	3280	>1000	>3280
R1000	Grey side, 18 % reflective	400	1320	500	1640	>500	>1640
R2000	White side, 90 % reflective	1500	4920	2000	6560	>2000	>6560
R2000	Grey side, 18 % reflective	750	2460	1000	3280	>1000	>3280

Range of measurement:

R1000: 1.5 m - 1200 m

R2000: 1.5 m - 2400 m

Distance measurements below 1.5 m are not possible.

### Atmospheric conditions

D: Object in strong sunlight, severe heat shimmer

E: Object in shade, sky overcast

F: Underground, night and twilight

### Accuracy

For TS50/TM50 - R1000:

Standard measuring	std. dev. ISO 17123-4	Measure time, typical [s]	Measure time, maximum [s]
0 m - 500 m	2 mm + 2 ppm	3	12
>500 m	4 mm + 2 ppm	6	12

Object in shade, sky overcast. Beam interruptions, severe heat shimmer and moving objects within the beam path can result in deviations of the specified accuracy. The display resolution is 0.1 mm.

For MS50 - R2000:

Standard measuring	std. dev. ISO 17123-4	Measure time, typical [s]	Measure time, maximum [s]
0 m - 500 m	2 mm + 2 ppm	1.5	12
>500 m	4 mm + 2 ppm	4	12

Object in shade, sky overcast. Beam interruptions, severe heat shimmer and moving objects within the beam path can result in deviations of the specified accuracy. The display resolution is 0.1 mm.

\* Auto point application increases the measurement time

### Characteristics

Type: Coaxial, visible red laser  
 Carrier wave: 658 nm  
 Measuring system: R1000: System analyser basis 100 MHz - 150 MHz  
 R2000: Wave Form Digitizer

**Laser dot size**

Distance [m]	Laser dot size, approximately [mm]
at 30	7 x 10
at 50	8 x 20
at 100	16 x 25

**7.4****Distance Measurement - Long Range (LO mode)****Availability**

Only available for TS50/TM50.

**Range**

Reflector	Range A		Range B		Range C	
	[m]	[ft]	[m]	[ft]	[m]	[ft]
Standard prism (GPR1, GPH1P)	2200	7300	7500	24600	>10000	>32800

Range of measurement:

1000 m to 12000 m

Display unambiguous:

up to 12000 m

**Atmospheric conditions**

Range A: Strong haze, visibility 5 km; or strong sunlight, severe heat shimmer

Range B: Light haze, visibility about 20 km; or moderate sunlight, slight heat shimmer

Range C: Overcast, no haze, visibility about 40 km; no heat shimmer

**Accuracy**

Standard measuring	std. dev. ISO 17123-4	Measure time, typical [s]	Measure time, maximum [s]
Long Range	3 mm + 1 ppm	2.5	12

Beam interruptions, severe heat shimmer and moving objects within the beam path can result in deviations of the specified accuracy. The display resolution is 0.1 mm.

**Characteristics**

Principle: Phase measurement

Type: Coaxial, visible red laser

Carrier wave: 658 nm

Measuring system: System analyser basis 100 MHz - 150 MHz

**7.5****Automatic Target Aiming ATR****Range ATR/LOCK**



For MS50/TS50:

Prism	Range ATR mode		Range Lock mode	
	[m]	[ft]	[m]	[ft]
Standard prism (GPR1)	1000	3300	800	2600
360° prism (GRZ4, GRZ122)	800	2600	600	2000
360° Mini prism (GRZ101)	350	1150	200	660
Mini prism (GMP101)	500	1600	400	1300
Reflector tape (GZM31) 60 mm x 60 mm	45	150	not qualified	
Machine Automation power prism (MPR122)  For Machine Control purposes only!	600	2000	500	1600

Prism	Range ATR mode		Range Lock mode	
	[m]	[ft]	[m]	[ft]
 The maximum range can be restricted by poorer conditions, for example rain.				

Shortest measuring distance: 360° prism ATR: 1.5 m  
Shortest measuring distance: 360° prism LOCK: 5 m

**For TM50:**

Prism	Range ATR mode up to*	
	[m]	[ft]
Standard prism (GPR1)	3000	9900
360° prism (GRZ4, GRZ122)	1500	5000
360° Mini prism (GRZ101)	700	2310
Mini prism (GMP101)	1000	3300
Reflector tape (GZM31) 60 mm x 60 mm	45	150
Machine Automation power prism (MPR122)  For Machine Control purposes only!	1200	3960
 The maximum range can be restricted by poorer conditions, for example rain.		

\* Atmospheric conditions type C, target aligned to instrument  
Shortest measuring distance: 360° prism ATR: 1.5 m

**ATR accuracy with the GPR1 prism**

ATR angle accuracy Hz, V (std. dev. ISO 17123-3, atmospheric conditions type C):  
TS50/TM50, 0.5": 0.5 " (0.15 mgon)  
MS50/TS50/TM50, 1": 1 " (0.3 mgon)

**Measurement accuracy with ATR**

- The accuracy with which the position of a prism can be determined with Automatic Target Aiming (ATR) depends on several factors such as internal ATR accuracy, instrument angle accuracy, prism type, selected EDM measuring program and the external measuring conditions.
- The following graph shows the typical ATR measurement accuracies based on three different prism types, distances and instrument accuracies.

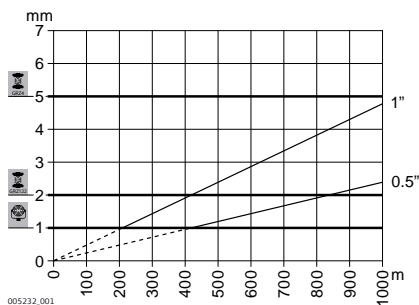

Leica GRZ4 prism (360°)



Leica GRZ122 prism (360°)



Leica circular prisms and Leica circular Mini prisms

mm

ATR accuracy [mm]

m

Distance measurement [m]

"

Instrument angle accuracy ["]

**Maximum speed in lock mode** Maximum tangential speed: 9 m/s at 20 m; 45 m/s at 100 m  
 Maximum radial speed with **Measure mode**: 5 m/s  
**Continuous**

**Searching** Typical search time in field of view: 1.5 s  
 Field of view: For MS50/TS50: 1°25'/1.55 gon  
 For TM50: 0°28'/0.52 gon  
 Definable search windows: Yes

**Characteristics** Principle: Digital image processing  
 Type: Infrared laser

## 7.6 Scanning

**Availability** Available for MS50 R2000 and on CS when connected to MS50 R2000.

**Range** The following ranges refer to optimal measurement conditions (object in shade, sky overcast, static target object).

Mode	Kodak Grey Card (Albedo 90%)	Range, up to	
		[m]	[ft]
1000 Hz	White side, 90% Albedo	300	980
250 Hz		400	1310
62 Hz		500	1640
>1 Hz		1000	3280

Shortest measuring distance: 1.5 m

**Accuracy** Range noise\* (1 sigma; Kodak Grey Card (Albedo 90%)):

Distance	1000 Hz	250 Hz	62 Hz	1 Hz
10 m	0.6 mm	0.5 mm	0.4 mm	0.4 mm
25 m	0.8 mm	0.6 mm	0.5 mm	0.5 mm
50 m	1.0 mm	0.8 mm	0.6 mm	0.6 mm
100 m	2.0 mm	1.0 mm	0.8 mm	0.8 mm
200 m	6.0 mm	3.0 mm	2.0 mm	1.8 mm

Object in shade, sky overcast. Beam interruptions, severe heat shimmer and moving objects within the beam path can result in deviations of the specified range noise and accuracy.

- \* Range noise describes the standard deviation of the scan points residuals to the modelled surface:
- Plane surface target
  - Perpendicular orientation of the plane target to the measurement direction
  - Modelled plane best fitted into the point cloud

The absolute position accuracy of a modelled surface is similar to an RL single measurement:

Standard measuring	std. dev. ISO 17123-4
0 m - 500 m	2 mm + 2 ppm
>500 m	4 mm + 2 ppm



## 7.7

## PowerSearch PS

### Range

Reflector	Range PS	
	[m]	[ft]
Standard prism (GPR1)	300	1000
360° prism (GRZ4, GRZ122)	300*	1000*
360° mini prism (GRZ101)	Not recommended	
Mini prism (GMP101)	100	330
Machine Automation power prism (MPR122)  For Machine Control purposes only!	300*	1000*

Measurements at the vertical limits of the fan or under unfavourable atmospheric conditions may reduce the maximum range. (\*optimally aligned to the instrument)

Shortest measuring distance: 1.5 m

### Searching

Typical search time: 5 - 10 s  
Rotating Speed: up to 100 gon/s  
Default search area: Hz: 400 gon, V: 40 gon  
Definable search windows: Yes

### Characteristics

Principle: Digital signal processing  
Type: Infrared laser

## 7.8

### Overview Camera

#### Overview camera

Sensor: 5 Mpixel CMOS sensor  
Focal length: 21 mm  
Field of view: 15.5° x 11.7° (19.4° diagonal)  
Frame rate: ≤20 frames per second  
Focus: 2 m (6.6 ft) to infinity at zoom level 1 x  
7.5 m (24.6 ft) to infinity at zoom level 4 x  
Image storage: JPEG up to 5 Mpixel (2560 x 1920)  
Zoom: 4-step (1x, 2x, 4x, 8x)  
Whitebalance: Automatic and user configurable  
Brightness: Automatic and user configurable

## 7.9

### Telescope Camera

#### Telescope camera

Sensor: 5 Mpixel CMOS sensor  
Focal length: At ∞ 231mm  
Field of view: 1.5° diagonal  
Frame rate: ≤20 frames per second  
Focus: Servofocus: Manual motorised focus, available for all variants instrument types  
Autofocus: Automatic focusing, available for instruments with imaging functionality  
Time to focus: Typical 2 s  
Focus range: 1.7 m to infinity  
Image storage: JPEG up to 5 Mpixel (2560 x 1920)  
Zoom, digital: 4-step (1x, 2x, 4x, 8x)  
Whitebalance: Automatic and user configurable  
Brightness: Automatic and user configurable

**7.10**  
**7.10.1**

**SmartStation**  
**SmartStation Accuracy**



Measurement precision and accuracy in position and accuracy in height are dependent upon various factors including the number of satellites tracked, constellation geometry, observation time, ephemeris accuracy, ionospheric disturbance, multipath and resolved ambiguities. Figures quoted assume normal to favourable conditions. Times required are dependent upon various factors including number of satellites, geometry, ionospheric conditions, multipath and so on. GPS and GLONASS can increase performance and accuracy by up to 30 % relative to GPS only. A full Galileo and GPS L5 constellation will further increase measurement performance and accuracy.

**Accuracy**

Position accuracy: Horizontal: 10 mm + 1 ppm  
Vertical: 20 mm + 1 ppm  
When used within reference station networks the position accuracy is in accordance with the accuracy specifications provided by the reference station network.

**Initialisation**

Method: Real-time (RTK)  
Reliability of initialisation: Better than 99.99 %  
Time of initialisation: Typically 8 s, with 5 or more satellites on L1 and L2  
Range: Up to 50 km, assuming reliable data-link is available

**RTK data formats**

Formats for data reception: Leica proprietary GPS and GNSS real-time data formats, CMR, CMR+, RTCM V2.1 / 2.2 / 2.3 / 3.1

**7.10.2**

**SmartStation Dimensions**

**SmartStation dimensions**

**With GS15**

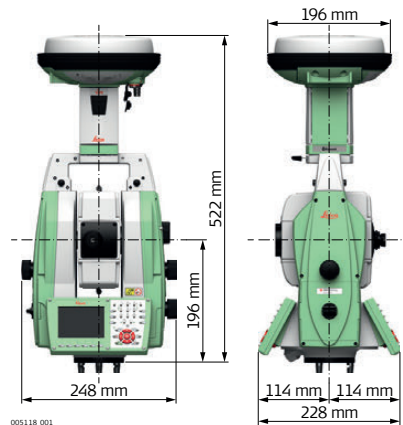

**With GS14**

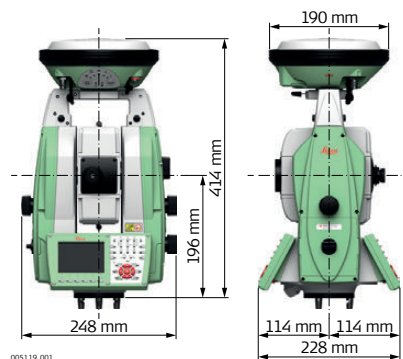

### With GS12

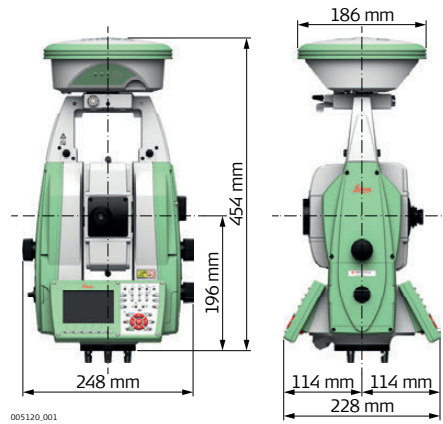

### With GS08plus

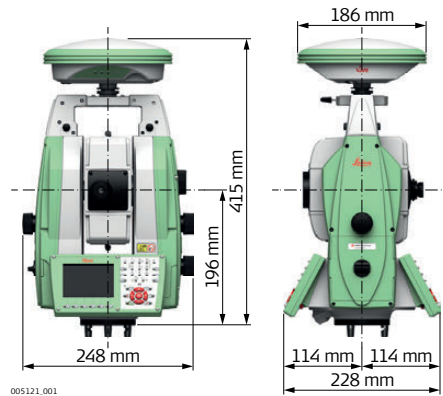

### With RH16

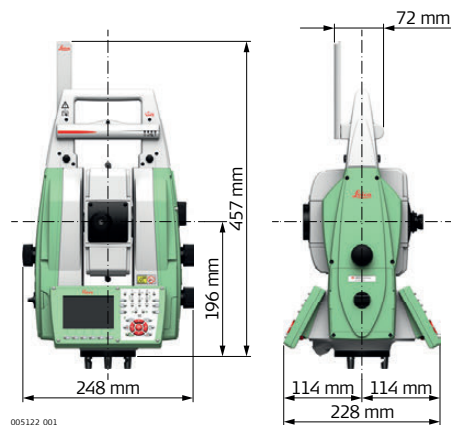

## 7.10.3

### SmartAntenna Technical Data

**Description and use** The SmartAntenna is selected for use based upon the application. The table gives a description and the intended use of the SmartAntenna.

Type	Description	Use
GS12/GS14/GS15	GPS, GLONASS, Galileo, BeiDou SmartTrack+ antenna with built-in groundplane.	With CS field controller or MS50/TS50/TM50.

Type	Description	Use
GS08plus	L1, L2 GPS, GLONASS SmartTrack+ antenna.	With CS field controller or MS50/TS50/TM50.

## Dimensions

Type	Height [m]	Diameter [m]
GS08plus	0.071	0.186
GS12	0.089	0.186
GS14	0.090	0.190
GS15	0.198	0.196

## Connector

- 8 pin LEMO-1 socket to connect antenna cable (only applicable when SmartAntenna is used independently on a pole with CS field controller).
- Special clip-on interface for connecting SmartAntenna to SmartAntenna Adapter on the instrument.

## Mounting

5/8" Whitworth

## Weight

1.1 kg including internal battery GEB211/GEB212

## Power

Power consumption: 1.8 W typically, 270 mA  
 External supply voltage: Nominal 12 V DC (---, GEV197 SmartAntenna to PC for data transfer and to external power supply), voltage range 10.5-28 V DC

## Battery internal

Type: Li-Ion  
 Voltage: 7.4 V  
 Capacity: GEB211: 2.2 Ah / GEB212: 2.6 Ah  
 Typical operating time: GEB211: 5.7 h / GEB212: 6.5 h

## Electrical data

Type	GS08plus	GS14	GS15
Frequency			
GPS L1 1575.42 MHz	✓	✓	✓
GPS L2 1227.60 MHz	✓	✓	✓
GPS L5 1176.45 MHz	-	-	✓
GLONASS L1 1602.5625-1611.5 MHz	✓	✓	✓
GLONASS L2 1246.4375-1254.3 MHz	✓	✓	✓
Galileo E1 1575.42 MHz	-	-	✓
Galileo E5a 1176.45 MHz	-	-	✓
Galileo E5b 1207.14 MHz	-	-	✓
Galileo Alt-BOC 1191.795 MHz	-	-	✓
Gain (typically)	37 dBi	27 dBi	27 dBi
Noise Figure (typically)	< 3 dBi	< 2 dBi	< 2 dBi



Galileo Alt-BOC covers bandwidth of Galileo E5a and E5b.

## Environmental specifications

### Temperature

Operating temperature [°C]	Storage temperature [°C]
-40 to +65 Bluetooth: -30 to +65	-40 to +80

### Protection against water, dust and sand

Protection	
GS08plus/GS12/GS15	GS14
IP67 (IEC 60529) Dusttight Protected against water jets  Waterproof to 1 m temporary immersion	IP68 (IEC 60529) Dusttight Protected against continuous immersion in water  Tested for 2 hours in 1.40 m depth

### Humidity

Protection
Up to 100 % The effects of condensation are to be effectively counteracted by periodically drying out the antenna.

## 7.11

### 7.11.1

## Conformity to National Regulations

### MS50/TS50/TM50

#### Conformity to national regulations

- FCC Part 15 (applicable in US)
- Hereby, Leica Geosystems AG, declares that the product MS50/TS50/TM50 is in compliance with the essential requirements and other relevant provisions of Directive 1999/5/EC and other applicable European Directives. The declaration of conformity may be consulted at <http://www.leica-geosystems.com/ce>.



Class 1 equipment according European Directive 1999/5/EC (R&TTE) can be placed on the market and be put into service without restrictions in any EU Member state.

- The conformity for countries with other national regulations not covered by the FCC part 15 or European directive 1999/5/EC has to be approved prior to use and operation.

#### Frequency band

Type	Frequency band [MHz]
Bluetooth	2402 - 2480
WLAN	2400 - 2483, channel 1-11 only

#### Output power

Type	Output power [mW]
Bluetooth	2.5
WLAN (802.11b)	50
WLAN (802.11g)	32

#### Antenna

Type	Antenna	Gain [dBi]	Connector	Frequency band [MHz]
Bluetooth	Integrated antenna	-	-	-

Type	Antenna	Gain [dBi]	Connector	Frequency band [MHz]
WLAN	Integrated antenna	-	-	-

### 7.11.2

#### RadioHandle

##### Conformity to national regulations

- FCC Part 15 (applicable in US)
- Hereby, Leica Geosystems AG, declares that the RadioHandle is in compliance with the essential requirements and other relevant provisions of Directive 1999/5/EC and other applicable European Directives. The declaration of conformity may be consulted at <http://www.leica-geosystems.com/ce>.



Class 1 equipment according European Directive 1999/5/EC (R&TTE) can be placed on the market and be put into service without restrictions in any EEA Member state.

- The conformity for countries with other national regulations not covered by the FCC part 15 or European directive 1999/5/EC has to be approved prior to use and operation.

##### Frequency band

RH15	Limited to 2402 - 2452 MHz
RH16	Limited to 2402 - 2480 MHz

##### Output power

< 100 mW (e. i. r. p.)

##### Antenna

Type:	$\lambda/2$ dipole antenna
Gain:	2 dBi
Connector:	Special customized SMB

### 7.11.3

#### GS08plus

##### Conformity to national regulations

- FCC Part 15, 22 and 24 (applicable in US)
- Hereby, Leica Geosystems AG, declares that the product GS08plus is in compliance with the essential requirements and other relevant provisions of Directive 1999/5/EC and other applicable European Directives. The declaration of conformity can be consulted at <http://www.leica-geosystems.com/ce>.



Class 1 equipment according European Directive 1999/5/EC (R&TTE) can be placed on the market and be put into service without restrictions in any EEA member state.

- The conformity for countries with other national regulations not covered by the FCC part 15, 22 and 24 or European directive 1999/5/EC has to be approved prior to use and operation.

##### Frequency band

Type	Frequency band [MHz]
GS08plus	1227.60 1575.42 1246.4375 - 1254.3 1602.4375 - 1611.5
Bluetooth	2402 - 2480

**Output power**

Type	Output power [mW]
GNSS	Receive only
Bluetooth	5 (Class 1)

**Antenna**

GNSS	Internal GNSS antenna element (receive only)
Bluetooth	Type: Internal Microstrip antenna Gain: 1.0 dBi

**7.11.4****GS12****Conformity to national regulations**

- FCC Part 15, 22 and 24 (applicable in US)
- Hereby, Leica Geosystems AG, declares that the product GS12 is in compliance with the essential requirements and other relevant provisions of Directive 1999/5/EC. The declaration of conformity can be consulted at <http://www.leica-geosystems.com/ce>.



Class 1 equipment according European Directive 1999/5/EC (R&TTE) can be placed on the market and be put into service without restrictions in any EEA member state.

- The conformity for countries with other national regulations not covered by the FCC part 15, 22 and 24 or European directive 1999/5/EC has to be approved prior to use and operation.

**Frequency band**

Type	Frequency band [MHz]
GS12	1176.45 1191.795 1207.14 1227.60 1246.4375 - 1254.3 1575.42 1602.4375 - 1611.5
Bluetooth	2402 - 2480



**Output power**

Type	Output power [mW]
GNSS	Receive only
Bluetooth	5 (Class 1)

**Antenna**

GNSS	Internal GNSS antenna element (receive only)
Bluetooth	Type: Internal Microstrip antenna Gain: 1.5 dBi

**Conformity to national regulations**

- FCC Part 15 (applicable in US)
  - Hereby, Leica Geosystems AG, declares that the product GS14 is in compliance with the essential requirements and other relevant provisions of Directive 1999/5/EC and other applicable European Directives. The declaration of conformity can be consulted at <http://www.leica-geosystems.com/ce>.
  - This Class 2 equipment may be operated in: AT, BE, CY, CZ, DK, EE, FI, FR, DE, GR, HU, IE, IT, LV, LT, LU, MT, NL, PL, PT, SK, SI, ES, SE, GB, IS, LI, NO, CH, BG, RO and TR.
-   Class 2 equipment according European Directive 1999/5/EC (R&TTE) for which following EEA Member States apply restrictions on the placing on the market or on the putting into service or require authorisation for use:
- France
  - Italy
  - Norway (if used in the geographical area within a radius of 20km from the centre of Ny-Ålesund)
- The conformity for countries with other national regulations not covered by the FCC part 15 or European directive 1999/5/EC has to be approved prior to use and operation.
  - Japanese Radio Law and Japanese Telecommunications Business Law Compliance (applicable for Japan).
    - This device is granted pursuant to the Japanese Radio Law and the Japanese Telecommunications Business Law.
    - This device should not be modified (otherwise the granted designation number will become invalid).

**Frequency band**

Type	Frequency band [MHz]
GS14	1227.60 1246.4375 - 1254.3 1575.42 1602.5625 - 1611.5
GS14, Bluetooth	2402 - 2480
GS14, Radio	403 - 473
GS14, 2G GSM	Quad-Band EGSM 850 / 900 / 1800 / 1900 GPRS multi-slot class 10

**Output power**

Type	Output power [mW]
GNSS	Receive only
Bluetooth	5
Radio	Receive only
2G GSM EGSM850/900	2000
2G GSM GSM1800/1900	1000

**Antenna**

Type	Antenna	Gain [dBi]
GNSS	Internal GNSS antenna element (receive only)	-
Bluetooth	Internal Microstrip antenna	2 max.
UHF	External antenna	-
2G GSM	Integrated antenna	1 max. @ 850 / 900 (preliminary) 4 max. @ 1800 / 1900 (preliminary)



**Conformity to national regulations**

- FCC Part 15, 22 and 24 (applicable in US)
- Hereby, Leica Geosystems AG, declares that the product GS15 is in compliance with the essential requirements and other relevant provisions of Directive 1999/5/EC. The declaration of conformity can be consulted at <http://www.leica-geosystems.com/ce>.



Class 1 equipment according European Directive 1999/5/EC (R&TTE) can be placed on the market and be put into service without restrictions in any EEA member state.

- The conformity for countries with other national regulations not covered by the FCC part 15, 22 and 24 or European directive 1999/5/EC has to be approved prior to use and operation.
- Japanese Radio Law and Japanese Telecommunications Business Law Compliance (applicable for Japan).
  - This device is granted pursuant to the Japanese Radio Law and the Japanese Telecommunications Business Law.
  - This device should not be modified (otherwise the granted designation number will become invalid).

**Frequency band**

Type	Frequency band [MHz]
GS15	1176.45 1191.795 1207.14 1227.60 1246.4375 - 1254.3 1575.42 1602.4375 - 1611.5
Bluetooth	2402 - 2480

**Output power**

Type	Output power [mW]
GNSS	Receive only
Bluetooth	5 (Class 1)

**Antenna**

Type	Antenna	Gain [dBi]	Connector	Frequency band [MHz]
GNSS	Internal GNSS antenna element (receive only)	-	-	-
Bluetooth	Internal Microstrip antenna	1.5	-	-

**Conformity to national regulations**

- FCC Part 15 (applicable in US)
- Hereby, Leica Geosystems AG, declares that the product SLR1, SLR2 is in compliance with the essential requirements and other relevant provisions of Directive 1999/5/EC and other applicable European Directives. The declaration of conformity can be consulted at <http://www.leica-geosystems.com/ce>.
- This Class 2 equipment may be operated in: AT, BE, CY, CZ, DK, EE, FI, FR, DE, GR, HU, IE, IT, LV, LT, LU, MT, NL, PL, PT, SK, SI, ES, SE, GB, IS, LI, NO, CH, BG, RO and TR.



Class 2 equipment according European Directive 1999/5/EC (R&TTE) for which following EEA Member States apply restrictions on the placing on the market or on the putting into service or require authorisation for use:

- France
- Italy
- Norway (if used in the geographical area within a radius of 20km from the centre of Ny-Ålesund)
- The conformity for countries with other national regulations not covered by the FCC part 15 or European directive 1999/5/EC has to be approved prior to use and operation.

**Frequency band**

403 MHz - 470 MHz

**Output power**

SLR1: 0.5 W-1.0 W  
SLR2: Receive only

**Antenna**

Type	Internal	GAT1	GAT2
Frequency band [MHz]	400 - 470	400 - 435	435 - 470
Type	Internal	Detachable $\lambda/2$ antenna	Detachable $\lambda/2$ antenna
Connector	-	TNC	TNC

**Specific Absorption Rate (SAR)**

The product meets the limits for the maximum permissible exposure of the guide-lines and standards which are force in this respect. The product must be used with the recommended antenna. A separation distance of at least 20 centimetres should be kept between the antenna and the body of the user or nearby person within the intended application.

**Conformity to national regulations**

- FCC Part 15 (applicable in US)
- Hereby, Leica Geosystems AG, declares that the product SLR5 is in compliance with the essential requirements and other relevant provisions of Directive 1999/5/EC and other applicable European Directives. The declaration of conformity can be consulted at <http://www.leica-geosystems.com/ce>.

- This Class 2 equipment may be operated in: AT, BE, CY, CZ, DK, EE, FI, FR, DE, GR, HU, IE, IT, LV, LT, LU, MT, NL, PL, PT, SK, SI, ES, SE, GB, IS, LI, NO, CH, BG, RO and TR.



Class 2 equipment according European Directive 1999/5/EC (R&TTE) for which following EEA Member States apply restrictions on the placing on the market or on the putting into service or require authorisation for use:

- France
- Italy
- Norway (if used in the geographical area within a radius of 20km from the centre of Ny-Ålesund)
- The conformity for countries with other national regulations not covered by the FCC part 15 or European directive 1999/5/EC has to be approved prior to use and operation.

**Frequency band**

403 MHz - 470 MHz

**Output power**

SLR5: 0.5 W-1.0 W

**Antenna**

Type	Internal	GAT1	GAT2
Frequency band [MHz]	400 - 470	400 - 435	435 - 470
Type	Internal	Detachable $\lambda/2$ antenna	Detachable $\lambda/2$ antenna
Connector	-	TNC	TNC

**Specific Absorption Rate (SAR)**

The product meets the limits for the maximum permissible exposure of the guide-lines and standards which are force in this respect. The product must be used with the recommended antenna. A separation distance of at least 20 centimetres should be kept between the antenna and the body of the user or nearby person within the intended application.

**Conformity to national regulations**

- FCC Part 15 (applicable in US)
- Hereby, Leica Geosystems AG, declares that the product SLR3-1, SLR3-2 is in compliance with the essential requirements and other relevant provisions of Directive 1999/5/EC and other applicable European Directives. The declaration of conformity can be consulted at <http://www.leica-geosystems.com/ce>.
- This Class 2 equipment may be operated in: AT, BE, CY, CZ, DK, EE, FI, FR, DE, GR, HU, IE, IT, LV, LT, LU, MT, NL, PL, PT, SK, SI, ES, SE, GB, IS, LI, NO, CH, BG, RO and TR.



Class 2 equipment according European Directive 1999/5/EC (R&TTE) for which following EEA Member States apply restrictions on the placing on the market or on the putting into service or require authorisation for use:

- France
- Italy
- Norway (if used in the geographical area within a radius of 20km from the centre of Ny-Ålesund)
- The conformity for countries with other national regulations not covered by the FCC part 15 or European directive 1999/5/EC has to be approved prior to use and operation.

**Frequency band**

SLR3-1: 390 MHz - 430 MHz  
SLR3-2: 430 MHz - 470 MHz

**Output power**

SLR3-1: 0.5 W-1 W  
SLR3-2: 0.5 W-1 W

**Antenna**

Type	Internal	GAT1	GAT2
Frequency band [MHz]	400 - 470	400 - 435	435 - 470
Type	Internal	Detachable $\lambda/2$ antenna	Detachable $\lambda/2$ antenna
Connector	-	TNC	TNC

**Specific Absorption Rate (SAR)**

The product meets the limits for the maximum permissible exposure of the guide-lines and standards which are force in this respect. The product must be used with the recommended antenna. A separation distance of at least 20 centimetres should be kept between the antenna and the body of the user or nearby person within the intended application.

**Conformity to national regulations**

- FCC Part 15, 22 and 24 (applicable in US)
- Hereby, Leica Geosystems AG, declares that the SLG1 is in compliance with the essential requirements and other relevant provisions of Directive 1999/5/EC and other applicable European Directives. The declaration of conformity may be consulted at <http://www.leica-geosystems.com/ce>.



Class 1 equipment according European Directive 1999/5/EC (R&TTE) can be placed on the market and be put into service without restrictions in any EEA Member state.

- The conformity for countries with other national regulations not covered by the FCC part 15, 22 and 24 or European directive 1999/5/EC has to be approved prior to use and operation.

**Frequency band**

UMTS/HSDPA (WCDMA/FDD) 850 MHz/ 1900 MHz/ 2100 MHz  
 Quad-Band EGSM 850 MHz/ 900 MHz/ 1800 MHz/ 1900 MHz  
 GPRS multi-slot class 12  
 EDGE multi-slot class 12

**Output power**

EGSM850/900: 2 W  
 GSM1800/1900: 1 W  
 UMTS2100: 0.25 W  
 EDGE850/900: 0.5 W  
 EDGE1800/1900: 0.4 W

**Antenna**

Type	GS15 Internal	GAT3	GAT5	GAT18
Frequency band [MHz]	824 - 894 / 890 - 960 / 1710 - 1880 / 1850 - 1990 / 1920 - 2170	890 - 960 / 1710 - 1880 / 1920 - 2170	824 - 894 / 1850 - 1990	824 - 894 / 890 - 960 / 1710 - 1880 / 1850 - 1990 / 1920 - 2170
Type	Internal	Detachable $\lambda/2$ antenna	Detachable $\lambda/2$ antenna	Detachable $\lambda/2$ antenna
Connector	-	TNC	TNC	TNC

**Specific Absorption Rate (SAR)**

The product meets the limits for the maximum permissible exposure of the guide-lines and standards which are force in this respect. The product must be used with the recommended antenna. A separation distance of at least 20 centimetres should be kept between the antenna and the body of the user or nearby person within the intended application.

**Conformity to national regulations**

- FCC Part 15, 22 and 24 (applicable in US)
- Hereby, Leica Geosystems AG, declares that the SLG2 is in compliance with the essential requirements and other relevant provisions of Directive 1999/5/EC and other applicable European Directives. The declaration of conformity may be consulted at <http://www.leica-geosystems.com/ce>.



Class 1 equipment according European Directive 1999/5/EC (R&TTE) can be placed on the market and be put into service without restrictions in any EEA Member state.

- The conformity for countries with other national regulations not covered by the FCC part 15, 22 and 24 or European directive 1999/5/EC has to be approved prior to use and operation.

**Frequency band**

Quad-Band EGSM850 MHz/ EGSM900 MHz/ GSM1800 MHz/ GSM1900 MHz

**Output power**

EGSM850/900: 2 W  
GSM1800/1900: 1 W

**Antenna**

Type	GS15 Internal	GAT3	GAT5	GAT18
Frequency band [MHz]	824 - 894 / 890 - 960 / 1710 - 1880 / 1850 - 1990 / 1920 - 2170	890 - 960 / 1710 - 1880 / 1920 - 2170	824 - 894 / 1850 - 1990	824 - 894 / 890 - 960 / 1710 - 1880 / 1850 - 1990 / 1920 - 2170
Type	Internal	Detachable $\lambda/2$ antenna	Detachable $\lambda/2$ antenna	Detachable $\lambda/2$ antenna
Connector	-	TNC	TNC	TNC

**Specific Absorption Rate (SAR)**

The product meets the limits for the maximum permissible exposure of the guide-lines and standards which are force in this respect. The product must be used with the recommended antenna. A separation distance of at least 20 centimetres should be kept between the antenna and the body of the user or nearby person within the intended application.

## 7.11.12

## SLC1 (US), SLC2 (US) CDMA Telit CC864-DUAL

- Conformity to national regulations**
- FCC Part 15, 22 and 24 (applicable in US)
  - The conformity for countries with other national regulations not covered by the FCC part 15, 22 and 24 has to be approved prior to use and operation.

**Frequency band** Dual-Band CDMA800 MHz/CDMA1900 MHz

**Output power**

CDMA800:	0.27 W
CDMA1900:	0.4 W

### Antenna

Type	Internal	GAT5	GAT18
Frequency band [MHz]	824 - 894 / 890 - 960 / 1710 - 1880 / 1850 - 1990 / 1920 - 2170	824 - 894 / 1850 - 1990	824 - 894 / 890 - 960 / 1710 - 1880 / 1850 - 1990 / 1920 - 2170
Type	Internal	Detachable $\lambda/2$ antenna	Detachable $\lambda/2$ antenna
Connector	-	TNC	TNC

**Specific Absorption Rate (SAR)** The product meets the limits for the maximum permissible exposure of the guide-lines and standards which are force in this respect. The product must be used with the recommended antenna. A separation distance of at least 20 centimetres should be kept between the antenna and the body of the user or nearby person within the intended application.

## 7.12

## General Technical Data of the Instrument

### Telescope

Magnification:	30 x
Clear objective diameter:	40 mm
Focusing:	1.7 m/5.6 ft to infinity
Field of view:	1°30'/1.66 gon.
	2.7 m at 100 m

### Compensator

Type	Setting accuracy		Setting range	
	["]	[mgon]	[']	[gon]
MS50/TS50/TM50	0.5	0.15	4	0.07

### Level

Compensation:	Centralised quadruple axis compensation
Circular level sensitivity:	6'/2 mm
Electronic level resolution:	2"

### Control unit

Display:	VGA (640 x 480 pixels), colour, graphics capable LCD, illumination, touch screen
Keyboard:	34 keys including 12 function keys, 12 alphanumeric keys and a user defined SmartKey, illumination
Angle Display:	360°", 360° decimal, 400 gon, 6400 mil, V %
Distance Display:	m, ft int, ft us, ft int inch, ft us inch
Position:	TM50 face I only, TS50/MS50 both faces
Touch screen:	Toughened film on glass

### Instrument ports

Name	Description
Serial/USB	<ul style="list-style-type: none"> <li>8 pin LEMO-1 for power, communication, data transfer.</li> <li>This port is located at the base of the instrument.</li> </ul>
Handle	<ul style="list-style-type: none"> <li>Hotshoe connection for RadioHandle with RCS and SmartAntenna Adapter with SmartStation.</li> <li>This port is located on top of Communication side cover.</li> </ul>
BT	<ul style="list-style-type: none"> <li>Bluetooth module for communication.</li> <li>This port is housed within Communication side cover.</li> </ul>
WLAN	<ul style="list-style-type: none"> <li>WLAN module for communication.</li> <li>This port is housed within Communication side cover.</li> </ul>

### Instrument dimensions

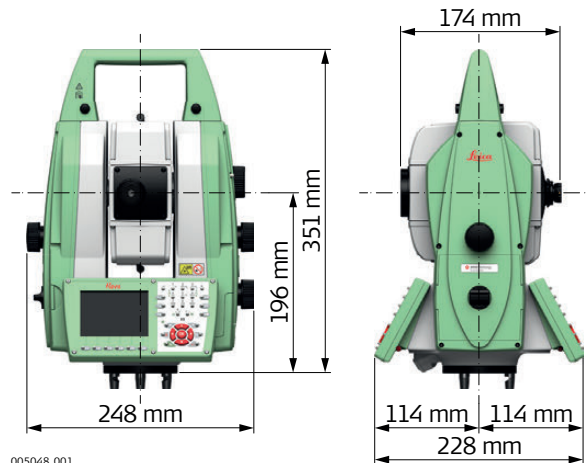



<b>Weight</b>	Instrument:	7.25 kg
	Tribrach:	0.8 kg
	Internal battery:	0.43 kg

**Recording** Data can be recorded onto an SD card or into internal memory.

Type	Capacity [MB]	Number of measurements per MB
SD card	<ul style="list-style-type: none"> <li>1024</li> <li>8192</li> </ul>	1750
Internal memory	<ul style="list-style-type: none"> <li>1000</li> </ul>	1750

<b>Laser plummet</b>	Type:	Visible red laser class 2
	Location:	In standing axis of instrument
	Accuracy:	Deviation from plumbline: 1 mm at 1.5 m instrument height
	Diameter of laser point:	2 mm at 1.5 m instrument height

<b>Operation</b>	Three endless drives:	For one and two hand manual operation
	User defined Smartkey:	Fast precision triggerkey for manual high precision measurements

<b>Motorisation</b>	Maximum acceleration:	400 gon/s <sup>2</sup>
	Maximum rotating speed:	200 gon/s
	Time for change face:	Typically 2.9 s

<b>Power</b>	External supply voltage:	Nominal voltage 12.8 V DC Range 12 V-18 V
	Standby power consumption:	Typically 0.3 W
	Operating power consumption:	Typically 8 W (max. 40 W)

<b>Internal battery</b>	Type:	Li-Ion
	Voltage:	14.8 V
	Capacity:	GEB242: 5.8 Ah

<b>External battery</b>	Type:	NiMH
	Voltage:	12 V
	Capacity:	GEB171: 9.0 Ah

**Environmental specifications**

**Temperature**

Type	Operating temperature [°C]	Storage temperature [°C]
MS50/TS50/TM50	-20 to +50	-40 to +70
Leica SD cards, all sizes	-40 to +80	-40 to +80
Battery internal	-20 to +55	-40 to +70
Bluetooth	-30 to +60	-40 to +80

**Protection against water, dust and sand**

Type	Protection
MS50/TS50/TM50	IP65 (IEC 60529)

## Humidity

Type	Protection
MS50/TS50/TM50	Max 95 % non condensing The effects of condensation are to be effectively counteracted by periodically drying out the instrument.

## Reflectors

Type	Additive Constant [mm]	ATR	PS
Standard prism, GPR1	0.0	yes	yes
Mini prism, GMP101	+17.5	yes	yes
360° prism, GRZ4 / GRZ122	+23.1	yes	yes
360° Mini prism, GRZ101	+30.0	yes	not recommended
Reflector tape S, M, L	+34.4	yes	no
Reflectorless	+34.4	no	no
Machine Automation power prism, MPR122  For Machine Control purposes only!	+28.1	yes	yes

There are no special prisms required for ATR or for PS.

## Electronic Guide Light EGL

Working range:	5 m to 150 m (15 ft to 500 ft)
Position accuracy:	5 cm at 100 m (1.97" at 330 ft)

## Automatic corrections

The following automatic corrections are made:

- Line of sight error
- Tilting axis error
- Earth curvature
- Circle eccentricity
- Compensator index error
- Vertical index error
- Standing axis tilt
- Refraction
- ATR zero point error
- Telescope camera zero point error

## 7.13

### Scale Correction

#### Use of scale correction

By entering a scale correction, reductions proportional to distance can be taken into account.

- Atmospheric correction.
- Reduction to mean sea level.
- Projection distortion.

#### Atmospheric correction $\Delta D1$

The slope distance displayed is correct if the scale correction in ppm, mm/km, which has been entered corresponds to the atmospheric conditions prevailing at the time of the measurement.

The atmospheric correction includes:

- Adjustments for air pressure
- Air temperature
- Relative humidity

For highest precision distance measurements, the atmospheric correction should be determined with an accuracy of 1 ppm. The following parameters must be redetermined:

- Air temperature to 1 °C
- Air pressure to 3 mbar
- Relative humidity to 20 %

## Air humidity

The air humidity influences the distance measurement if the climate is extremely hot and damp.

For high precision measurements, the relative humidity must be measured and entered along with the air pressure and the temperature.

## Air humidity correction

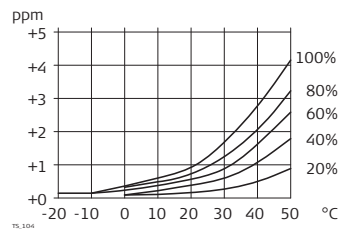

ppm Air humidity correction [mm/km]  
 % Relative humidity [%]  
 °C Air temperature [°C]

## Index n

Type	Index n	Carrier wave [nm]
MS50 with R2000 (Wave Form Digitiser)	1.0002863	658
TS50/TM50 with R1000 Combined EDM (Phase Shift / System Analyser)		

The index n is calculated from the formula of Barrel and Sears, and is valid for:

Air pressure p: 1013.25 mbar  
 Air temperature t: 12 °C  
 Relative air humidity h: 60 %

## Formulas

Formula for visible red laser

$$\Delta D_1 = 286.34 - \left[ \frac{0.29525 \cdot p}{(1 + \alpha \cdot t)} - \frac{4.126 \cdot 10^{-4} \cdot h}{(1 + \alpha \cdot t)} \right] \cdot 10^x$$

$\Delta D_1$  Atmospheric correction [ppm]

p Air pressure [mbar]

t Air temperature [°C]

h Relative humidity [%]

$$\alpha = \frac{1}{273.15}$$

$$x = (7.5 \cdot t / (237.3 + t)) + 0.7857$$

If the basic value of 60 % relative humidity as used by the EDM is retained, the maximum possible error in the calculated atmospheric correction is 2 ppm, 2 mm/km.

## Reduction to mean sea level $\Delta D_2$

The values for  $\Delta D_2$  are always negative and are derived from the following formula:

$$\Delta D_2 = - \frac{H}{R} \cdot 10^6$$

$\Delta D_2$  Reduction to mean sea level [ppm]

H Height of EDM above sea level [m]

$$R = 6.378 \cdot 10^6 \text{ m}$$

**Projection distortion  $\Delta D_3$**

The magnitude of the projection distortion is in accordance with the projection system used in a particular country, for which official tables are generally available. The following formula is valid for cylindrical projections such as that of Gauss-Krüger:

$$\Delta D_3 = \frac{X^2}{2R^2} \cdot 10^6$$

TS.107

$\Delta D_3$  Projection distortion [ppm]

X Easting, distance from projection zero line with the scale factor 1 [km]

R  $6.378 \cdot 10^6$  m

In countries where the scale factor is not unity, this formula cannot be directly applied.

**Atmospheric corrections  $^{\circ}C$**

Atmospheric corrections in ppm with temperature [ $^{\circ}C$ ], air pressure [mb] and height [m] at 60 % relative humidity.

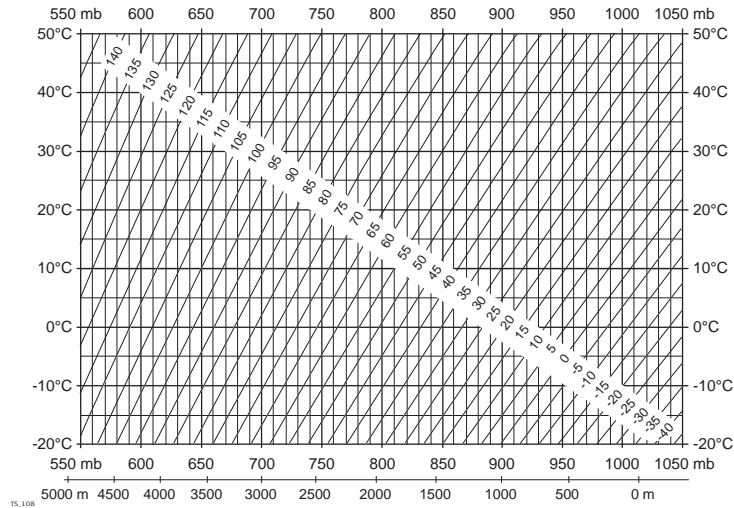

TS.108

**Atmospheric correction  $^{\circ}F$**

Atmospheric corrections in ppm with temperature [ $^{\circ}F$ ], air pressure [inch Hg] and height [ft] at 60 % relative humidity.

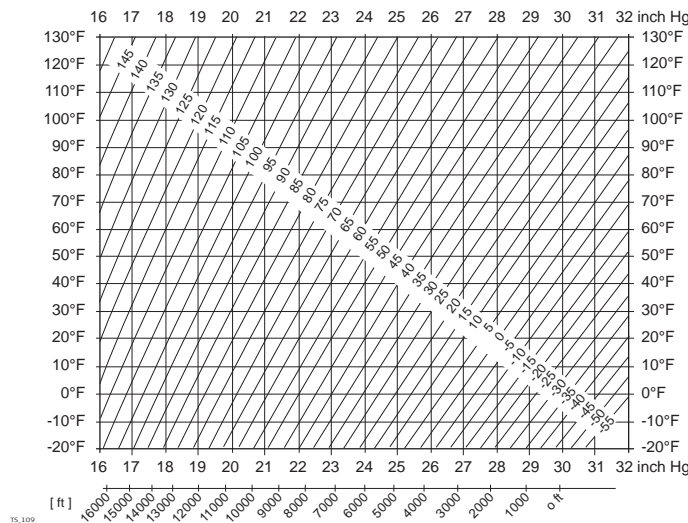

TS.109

## Measurements

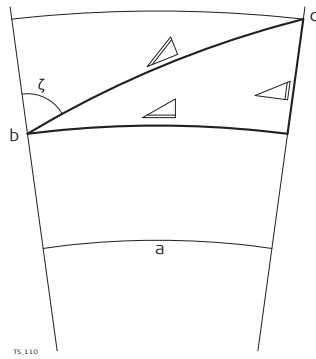

- a) Mean Sea Level
- b) Instrument
- c) Reflector
- ▴ Slope distance
- ▴ Horizontal distance
- ▴ Height difference

## Reflector types

The reduction formulas are valid for measurements to all reflector types:

- measurements to prisms, to reflector tape and reflectorless measurements.

## Formulas

The instrument calculates the slope distance, horizontal distance, height difference in accordance with the following formulas:

$$\text{▴} = D_0 \cdot (1 + \text{ppm} \cdot 10^{-6}) + \text{mm}$$

TS.111

- ▴ Displayed slope distance [m]
- $D_0$  Uncorrected distance [m]
- ppm Atmospheric scale correction [mm/km]
- mm Additive constant of the reflector [mm]

$$\text{▴} = Y - A \cdot X \cdot Y$$

TS.112

- ▴ Horizontal distance [m]
- ▴ Height difference [m]

$$Y \text{ ▴} \cdot |\sin \zeta|$$

$$X \text{ ▴} \cdot \cos \zeta$$

$\zeta$  Vertical circle reading

$$A \ (1 - k/2)/R = 1.47 \cdot 10^{-7} \text{ [m}^{-1}\text{]}$$

$$B \ (1 - k)/2R = 6.83 \cdot 10^{-8} \text{ [m}^{-1}\text{]}$$

$k$  0.13 (mean refraction coefficient)

$R$   $6.378 \cdot 10^6$  m (radius of the earth)

$$\text{▴} = X + B \cdot Y^2$$

TS.113

Earth curvature ( $1/R$ ) and mean refraction coefficient ( $k$ ) (if enabled on the Refraction page in Main Menu: Config...\Instrument Settings...\TPS Corrections) are automatically taken into account when calculating the horizontal distance and height difference. The calculated horizontal distance relates to the station height and not to the reflector height.

## Distance measuring program Averaging

In the distance measuring program Averaging, the following values are displayed:

- $\bar{D}$  Slope distance as arithmetic mean of all measurements
- $s$  Standard deviation of a single measurement
- $n$  Number of measurements

These values are calculated as follows:

$$\bar{D} = \frac{1}{n} \cdot \sum_{i=1}^n D_i$$

TS.114

- $\bar{D}$  Slope distance as arithmetic mean of all measurements
- $\Sigma$  Sum
- $D_i$  Single slope distance measurement
- $n$  Number of measurements

$$s = \sqrt{\frac{\sum_{i=1}^n (D_i - \bar{D})^2}{n - 1}} = \sqrt{\frac{\sum_{i=1}^n D_i^2 - \frac{1}{n} (\sum_{i=1}^n D_i)^2}{n - 1}}$$

TS.115

- s Standard deviation of a single slope distance measurement
- $\Sigma$  Sum
- $\bar{D}$  Slope distance as arithmetic mean of all measurements
- $D_i$  Single slope distance measurement
- n Number of distance measurements

The standard deviation  $S_{\bar{D}}$  of the arithmetic mean of the distance can be calculated as follows:

$$S_{\bar{D}} = \frac{s}{\sqrt{n}}$$

TS.116

- $S_{\bar{D}}$  Standard deviation of the arithmetic mean of the distance
- s Standard deviation of a single measurement
- n Number of measurements

### Software Licence Agreement

This product contains software that is preinstalled on the product, or that is supplied to you on a data carrier medium, or that can be downloaded by you online according to prior authorisation from Leica Geosystems. Such software is protected by copyright and other laws and its use is defined and regulated by the Leica Geosystems Software Licence Agreement, which covers aspects such as, but not limited to, Scope of the Licence, Warranty, Intellectual Property Rights, Limitation of Liability, Exclusion of other Assurances, Governing Law and Place of Jurisdiction. Please make sure, that at any time you fully comply with the terms and conditions of the Leica Geosystems Software Licence Agreement.

Such agreement is provided together with all products and can also be referred to and downloaded at the Leica Geosystems home page at <http://www.leica-geosystems.com/swlicense> or collected from your Leica Geosystems distributor.

You must not install or use the software unless you have read and accepted the terms and conditions of the Leica Geosystems Software Licence Agreement. Installation or use of the software or any part thereof, is deemed to be an acceptance of all the terms and conditions of such Licence Agreement. If you do not agree to all or some of the terms of such Licence Agreement, you must not download, install or use the software and you must return the unused software together with its accompanying documentation and the purchase receipt to the distributor from whom you purchased the product within ten (10) days of purchase to obtain a full refund of the purchase price.

---

### Open source information

The software on the product may contain copyright-protected software that is licensed under various open source licences.

Copies of the corresponding licences

- are provided together with the product (for example in the About panel of the software)
  - can be downloaded on <http://opensource.leica-geosystems.com/viva/smartworx>
- If foreseen in the corresponding open source licence, you may obtain the corresponding source code and other related data on <http://opensource.leica-geosystems.com/viva/smartworx>.

Contact [opensource@leica-geosystems.com](mailto:opensource@leica-geosystems.com) in case you need additional information.

---

<b>A</b>	
Accuracy	
Angle measurement .....	51
IR mode .....	52
LO mode .....	54
RL mode .....	53
Scanning .....	56
SmartStation .....	58
ActiveSync .....	30
Adjustment	
Combined (l, t, i, c, ATR and OAC) .....	44
Electronic .....	42
Inspecting laser plummet .....	47
Inspecting the laser plummet .....	48
Mechanical .....	42
Of circular level on instrument .....	47, 47
Of circular level on prism pole .....	47
Of circular level on tribrach .....	47, 47
Preparation .....	43
Titling axis (a) .....	45
Adjustment Errors	
View current .....	42
Angle measurement .....	51
Antenna	
GS14 .....	64
GS15 .....	65
RadioHandle .....	62
Antennas	
GS08plus .....	63
GS12 .....	63
Type .....	59
Automatic Corrections .....	74
Automatic Target Aiming ATR	
Accuracy with the GPR1 prism .....	55
Description .....	13
Measurement accuracy .....	55
Positioning of crosshairs .....	43
<b>B</b>	
Batteries	
Charging, first-time use .....	33
Operation, Discharging .....	33
Battery	
Change in SmartAntenna .....	34
Change in TS instrument .....	33
Internal, SmartAntenna .....	60
Labelling .....	19
Technical data GEB171 .....	73
Technical data GEB242 .....	73
<b>C</b>	
Bluetooth	
LED on GS08plus .....	37
LED on GS12 .....	37
LED on GS14 .....	38
LED on SmartAntenna .....	38
<b>C</b>	
Check & Adjust .....	42
CINTERION MC75i	
SLG2, technical data .....	70
Combined adjustment (l, t, i, c, ATR and telescope camera) .....	44
Communication side cover	
Description .....	25
Graphical overview with RadioHandle .....	26
Graphical overview with SmartStation .....	25
Compensator .....	72
Connector	
SmartAntenna .....	60
Control unit .....	72
Corrections	
Automatic .....	74
Scale .....	74
<b>D</b>	
Data transfer .....	24
Definition of Use .....	7
Description of the system .....	20
Dimensions	
Of instrument .....	72
Of SmartAntenna .....	60
Of SmartStation .....	58
Display foil .....	29
Distance Measurement	
Any surface mode .....	53
LO mode .....	54
Prism mode .....	51
Documentation .....	2
Drive	
PC card, on office computer .....	24
Drives .....	73
<b>E</b>	
Electrical data, SmartAntenna .....	60
Electronic Adjustment .....	42
Electronic Distance Measurement EDM	
Description .....	20
PinPoint .....	20
Electronic Guide Light EGL	
Description .....	21
Safety directions .....	15



Technical data .....	74	Instrument	
Environmental Specifications .....	73	Dimensions .....	72
SmartAntenna .....	61	Ports .....	72
<b>F</b>		Technical Data .....	72
FCC Statement .....	18	Weight .....	73
Frequency band		Instrument Models .....	22
GS08plus .....	62	Internal memory	
GS12 .....	63	Memory device .....	24, 24
GS15 .....	65	<b>K</b>	
SLC1, Telit CC864-DUAL .....	71	Keyboard	
SLC2, Telit CC864-DUAL .....	71	Operating principles .....	28
SLG1, Telit UC864-G .....	69	Keys	
SLG2, CINTERION MC75i .....	70	Alpha keys .....	27
SLR1, SATEL SATELLINE-3AS .....	66	Arrow keys .....	28
SLR2, SATEL SATELLINE-3AS .....	66	Description of .....	27
SLR3-1, Pacific Crest .....	68	ENTER key .....	27
SLR3-2, Pacific Crest .....	68	ESC key .....	27
SLR5, SATEL SATELLINE M3-TR1 .....	67	Favourites .....	27
Frequency Band .....	61	Fn key .....	27
RadioHandle .....	62	Function keys .....	27
<b>G</b>		Home .....	27
GAT 1, antenna .....	66, 67, 68	Hot keys .....	27
GAT 2, antenna .....	66, 67, 68	Numeric keys .....	27
GAT 3, antenna .....	69, 70	OK .....	28
GAT 5, antenna .....	69, 70, 71	ON/OFF .....	27
GAT18, antenna .....	69, 70, 71	<b>L</b>	
GeoC++ Software Development Kit .....	23	Labelling .....	19
GS08plus		GS08plus .....	18
Status .....	37	GS12 .....	18
GS12		GS14 .....	18
Status .....	37	GS15 .....	19
GS14		Laser	
Insert microSD card .....	36	Classification .....	10
Remove microSD card .....	36	Laser Classification	
Status .....	38	Automatic Target Aiming .....	13
GS15		Integrated Distancer, Invisible Laser .....	10
Insert SD card .....	36	Integrated Distancer, Visible Laser .....	11
Remove SD card .....	36	PowerSearch PS .....	14
Guidelines for Correct Results .....	40	Laser plummet	
<b>I</b>		Inspect .....	47
Indicators, LED		Safety directions .....	15
GS08plus .....	37	Technical data .....	73
GS12 .....	37	LED	
GS14 .....	38	GS08plus, description .....	37
GS15 .....	38	GS12, description .....	37
RadioHandle .....	39	Level .....	72
Insert		Light Emitting Diode	
SD card .....	35	GS08plus .....	37
USB stick .....	35	GS12 .....	37
		GS14 .....	38
		SmartAntenna .....	38

Li-Ion battery .....	60	Power supply .....	23
Storage .....	49	PowerSearch PS .....	57
<b>M</b>		Precise Measurements .....	42
Mechanical Adjustment .....	42	<b>R</b>	
Memory device		R1000 .....	20
Available .....	24	RadioHandle	
microSD card		Description .....	21
Insert .....	36	LED indicators .....	39
Remove .....	36	Technical data .....	62
Microsoft ActiveSync .....	30	Recording .....	73
Mount, SmartAntenna .....	60	Reduction Formulas .....	77
<b>O</b>		Reflectors .....	74
Operating principles .....	28	Remove	
Operating Temperature		SD card .....	35
SmartAntenna .....	61	USB stick .....	35
Operation .....	73	Reset	
Output power		Options .....	32
GS08plus .....	63	Responsibilities .....	7
GS10 .....	65	RTK Base	
GS12 .....	63	LED on GS14 .....	38
GS14 .....	64	LED on SmartAntenna .....	38
GS15 .....	65	RTK Rover	
SLC1, Telit CC864-DUAL .....	71	LED on GS14 .....	38
SLC2, Telit CC864-DUAL .....	71	LED on SmartAntenna .....	38
SLG1, Telit UC864-G .....	69	<b>S</b>	
SLG2, CINTERION MC75i .....	70	Safety Directions .....	6
SLR1, SATEL SATELLINE-3AS .....	66	SATELLINE	
SLR2, SATEL SATELLINE-3AS .....	66	SLR1, technical data .....	66
SLR3-1, Pacific Crest .....	68	SLR2, technical data .....	66
SLR3-2, Pacific Crest .....	68	SLR5, technical data .....	67
SLR5, SATEL SATELLINE M3-TR1 .....	67	SD card	
Output Power		Insert .....	35, 36
RadioHandle .....	62	Memory device .....	24
Overview Camera .....	57	Remove .....	35, 36
<b>P</b>		SLC1 .....	71
Pacific Crest		SLC2 .....	71
SLR3-1, technical data .....	68	SLG1 .....	69
SLR3-2, technical data .....	68	SLG2 .....	70
PC card drive on office computer .....	24	SLR1 .....	66
Ports .....	72	SLR2 .....	66
Position		SLR3-1 .....	68
LED on GS14 .....	38	SLR3-2 .....	68
LED on SmartAntenna .....	38	SLR5 .....	67
Power		SmartAntenna	
SmartAntenna .....	60	Description .....	21
Power LED		Dimensions .....	58
GS08plus .....	37	SmartStation	
GS12 .....	37	Components .....	21
GS14 .....	38	Communication side cover .....	21
SmartAntenna .....	38	Description .....	21
		Graphical overview .....	25

SmartAntenna .....	21	Transfer data .....	24
Technical Data		TS	
Accuracy .....	58	Display foil .....	29
Dimensions .....	58	Firmware for TS .....	22
Software		Language software for TS .....	22
Applications .....	22	Lock keyboard .....	32
Customised applications .....	23	Power Options menu .....	32
Software type .....	22	Unlock keyboard .....	32
Upload .....	23	<b>U</b>	
Software Licence Agreement .....	79	Upload software .....	23
Specifications, environmental		USB stick	
SmartAntenna .....	61	Insert .....	35
Status		Memory device .....	24
GS14 .....	38	Remove .....	35
Status, GS08plus .....	37	User Interface .....	27
Status, GS12 .....	37	User Manual	
Storage		Validity of .....	2
LED on GS14 .....	38	<b>V</b>	
LED on SmartAntenna .....	38	View Current Adjustment Errors .....	42
Storage Temperature		<b>W</b>	
SmartAntenna .....	61	Weight	
<b>T</b>		Of instrument .....	73
Telescope .....	72	SmartAntenna .....	60
Telescope camera .....	57	Windows CE	
Telit CC864-DUAL		Reset registry .....	32
SLC1, technical data .....	71	Restart .....	32
SLC2, technical data .....	71	Windows Mobile Device Center .....	30
Telit UC864-G			
SLG1, technical data .....	69		
Temperature			
Battery Internal			
Operating .....	73		
Storage .....	73		
Bluetooth			
Operating .....	73		
Storage .....	73		
CompactFlash Card			
Storage .....	73		
Instrument			
Operating .....	73		
Storage .....	73		
SD card			
Operating .....	73		
Temperature, charging internal battery .....	33		
Terminology .....	20		
Touch screen			
Turn off .....	32		
Turn on .....	32		
Touch Screen, operating principles .....	28		
Tracking LED			
GS08plus .....	37		
GS12 .....	37		

**805805-1.1.1en**

Original text

Published in Switzerland

© 2013 Leica Geosystems AG, Heerbrugg, Switzerland

**Leica Geosystems AG**

Heinrich-Wild-Strasse

CH-9435 Heerbrugg

Switzerland

Phone +41 71 727 31 31

[www.leica-geosystems.com](http://www.leica-geosystems.com)

- when it has to be **right**

**Leica**  
Geosystems